

# EMOS®

A brand of **legrand®**

## Lighting Catalogue 2023/2024

**OPTIMAL  
PRICE/QUALITY RATIO  
OF PRODUCTS**

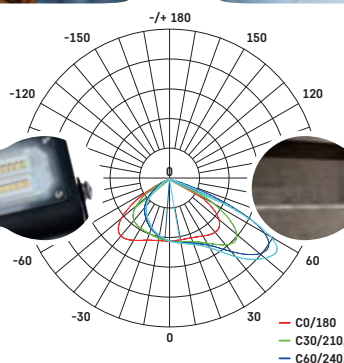

**24-HOUR STOCK  
AVAILABILITY**

**Making  
Life  
Easy**



# TABLE OF CONTENTS

## LED Work Floodlights and LED Floodlights

|                                      |           |
|--------------------------------------|-----------|
| <b>LED FLOODLIGHTS</b> .....         | <b>10</b> |
| ■ AGENO.....                         | 10        |
| ■ ASIMO.....                         | 12        |
| ■ INOVO.....                         | 16        |
| ■ INOVO PIR.....                     | 18        |
| ■ ILIO.....                          | 20        |
| ■ ILIO PIR.....                      | 21        |
| ■ TAMBO.....                         | 22        |
| ■ TAMBO PIR.....                     | 23        |
| □ SIMPO.....                         | 24        |
| □ SIMPO PIR.....                     | 26        |
| ACCESSORIES FOR LED FLOODLIGHTS..... | 28        |
| <b>LED WORK FLOODLIGHTS</b> .....    | <b>28</b> |
| ■ CANNO.....                         | 30        |
| ■ HOBBY SLIM.....                    | 31        |
| ■ ILIO.....                          | 32        |
| ■ ACCO.....                          | 33        |

## Room Luminaires

|   |           |
|---|-----------|
| <b>LED LINEAR</b> .....                 | <b>38</b> |
| ■ ORTO.....                             | 38        |
| <b>LARGE LED PANELS</b> .....           | <b>40</b> |
| ■ TROXO.....                            | 40        |
| ■ PROXO.....                            | 42        |
| ■ LEXXO.....                            | 44        |
| ■ PIXXO.....                            | 46        |
| ■ REXXO.....                            | 47        |
| ■ MAXXO.....                            | 48        |
| ■ DAXXO.....                            | 50        |
| ACCESSORIES FOR LED PANELS.....         | 51        |
| <b>SURFACE-MOUNTED LUMINAIRES</b> ..... | <b>52</b> |
| ■ ALVI.....                             | 56        |
| ■ ILVI.....                             | 58        |
| ■ ILVI GoSmart.....                     | 60        |
| ■ RIVI.....                             | 62        |
| ■ IRVI.....                             | 63        |
| ■ NEXXO.....                            | 64        |
| ■ CORI.....                             | 76        |
| ■ CORI SENSOR.....                      | 77        |
| ■ TORI.....                             | 78        |
| ■ TORI SENSOR.....                      | 79        |
| ■ ZURI.....                             | 80        |
| ■ ZURI PIR.....                         | 81        |
| ■ DORI.....                             | 82        |
| ■ QARI.....                             | 83        |
| □ FIORI.....                            | 84        |
| □ RUBIC.....                            | 86        |

|                                  |           |
|----------------------------------|-----------|
| <b>RECESSED LUMINAIRES</b> ..... | <b>88</b> |
| ■ SIMMI.....                     | 90        |
| ■ VIXXO.....                     | 92        |
| ■ NEXXO.....                     | 94        |
| ■ EXTENSIO.....                  | 106       |
| □ RUBIC.....                     | 108       |

## Industrial Luminaires

|                                   |            |
|-----------------------------------|------------|
| <b>HIGHBAYS</b> .....             | <b>112</b> |
| ■ ASTER.....                      | 112        |
| ■ CORUS.....                      | 114        |
| ACCESSORIES FOR HIGHBAYS.....     | 116        |
| <b>DUSTPROOF LUMINAIRES</b> ..... | <b>118</b> |
| ■ MISTY.....                      | 118        |
| ■ FESTY.....                      | 120        |
| □ DUSTY.....                      | 121        |

## Luminaires for Special Applications

|   |            |
|---|------------|
| <b>ORIENTATION LUMINAIRES</b> .....       | <b>124</b> |
| ■ AMAL.....                               | 124        |
| ■ DIRAL.....                              | 125        |
| ■ DIRBY.....                              | 126        |
| <b>EMERGENCY LUMINAIRES</b> .....         | <b>127</b> |
| ■ ORSU.....                               | 127        |
| ■ CESSI AND NESSI.....                    | 128        |
| ACCESSORIES FOR EMERGENCY LUMINAIRES..... | 129        |
| <b>CABINET LUMINAIRES</b> .....           | <b>130</b> |
| ■ TIGO.....                               | 130        |

## Lighting Electronics

|                          |            |
|--------------------------|------------|
| <b>SENSORS</b> .....     | <b>132</b> |
| PIR/MW SENSORS.....      | 132        |
| PIR SENSORS.....         | 133        |
| <b>LED DRIVERS</b> ..... | <b>134</b> |

## Light Sources

|                           |            |
|---------------------------|------------|
| <b>LED TUBES</b> .....    | <b>138</b> |
| ■ PROFI PLUS.....         | 138        |
| □ BASIC.....              | 139        |
| <b>LIGHT BULBS</b> .....  | <b>136</b> |
| VINTAGE.....              | 140        |
| TRUE LIGHT.....           | 142        |
| LED FILAMENT A-CLASS..... | 143        |
| LED FILAMENT D-CLASS..... | 144        |
| LED CLASSIC.....          | 146        |

|                                |            |
|--------------------------------|------------|
| <b>EMOS GoSmart</b> .....      | <b>150</b> |
| GoSmart Bulbs WIFI.....        | 150        |
| GoSmart Bulbs ZigBee.....      | 151        |
| GoSmart LED Strips WIFI.....   | 152        |
| GoSmart LED Strips ZigBee..... | 153        |

## EMOS GoSmart PRODUCTS.....156

### DATA SECURITY AND COMPATIBILITY.....156

### EMOS GoSmart APP.....157

|   |     |
|---|-----|
| GoSmart LED Luminaire ILVI.....             | 158 |
| GoSmart LED Christmas chain CLASSIC.....    | 159 |
| GoSmart LED Bulbs WIFI.....                 | 160 |
| GoSmart LED Bulbs ZigBee.....               | 161 |
| GoSmart LED Strips WIFI.....                | 162 |
| GoSmart LED Strips ZigBee.....              | 163 |
| GoSmart Multifunctional ZigBee gateway..... | 164 |
| GoSmart Extension cords and sockets.....    | 165 |
| GoSmart Scenic switches ZigBee.....         | 166 |

## INDEX.....168

### PROFI PLUS

Professional products of the highest quality designed for lighting projects that stand out with high luminous efficiency in combination with total reliability and economy operating costs.

Warranty: minimum **5 years**.

### PROFI/EXCLUSIVE

Products meeting high quality standards enabling professional deployment (Profi) or products with higher added value for the end user (Exclusive).

Warranty: minimum **3 years**.

### CLASSIC

The bestseller in our range is the Classic category. You will find in it lighting and light sources with the optimal of price/performance to suit the majority of most common applications.

Warranty: **2 or 3 years**.

### ESSENTIAL

Products for those for whom price is everything the main decision criterion. Despite their reasonable price, they meet all quality standards and legislative regulations for this type of products.

Warranty: **2 years**.

# EMOS®

A brand of  **legrand®**

## Making life easy

Our passion is electricity! We enjoy developing, sourcing and delivering electrical products that help our business partners succeed in today's highly competitive marketplace with their optimum price and quality.

For more than 30 years, EMOS companies have offered small household electrical products that are part of everyone's life. Under the EMOS brand there are mainly batteries, light sources and luminaires for domestic and industrial use, extension leads, flashlights, antennas, small electronic devices – multimeters, testers, bells. In five countries, there are over 450 people employed to ensure that our products are of the best quality and get delivered to you, our customers, as quickly as possible. Since 2022 EMOS companies have been part of the multinational Legrand Group.



Direct distributor for the Czech Republic, Slovakia, Hungary, Slovenia and Croatia.

[www.emos.eu](http://www.emos.eu)

## EMOS basic philosophy



**OPTIMAL PRICE/  
QUALITY RATIO OF  
PRODUCTS**

Each of our products is subject to strict quality control by a team of inspection staff directly at the manufacturer's site and then in our own laboratory. We carry out nearly 1,100 tests a year, supervised by 25 specialists



**24-HOUR  
STOCK  
AVAILABILITY**

We offer excellent stock availability of our products and fast delivery to our customers. A total storage area of over 16,000 m<sup>2</sup> allows us to keep more than 95% of the items in our range in stock and in sufficient inventory at all times.



**SPEED AND  
EASE OF  
COMMUNICATION**

Customers communicate with us in the way that suits them best - through sales representatives, online B2B and B2C portals or by phone. 90 EMOS Group sales representatives visit an average of 650 customers per day

## About the multinational Legrand Group

Legrand is a global specialist in electrical and digital infrastructure, offering high value-added products and solutions that improve lives by transforming the spaces where people live, work and meet. The Legrand Group employs more than 38,200 people in nearly 90 countries and works to improve buildings' electrical and digital infrastructures, helping to digitize them and reduce their carbon footprint. Legrand has solutions for all building types - residential buildings, data centers and other non-residential buildings; as well as industrial spaces and infrastructures. The Group's technological expertise, its leadership position, the breadth and diversity of its offering, its international presence and the strength of its brands combine to make Legrand a global leader.

[#LegrandImprovingLives](https://www.legrandgroup.com)

[www.legrandgroup.com](http://www.legrandgroup.com)

 @legrand

# EMOS dealership

## CZECH REPUBLIC

### Headquarters and logistics centre

EMOS spol. s r.o.  
Lipnická 2844  
750 02 Přerov

ID No.: 19014104  
tax ID No.: CZ19014104  
bank account number: 296149-831/0100  
e-mail: [emos@emos.cz](mailto:emos@emos.cz)

contact person: +420 581 261 111  
customer centre B2B: +420 581 261 270-272  
customer centre B2C: +420 581 261 233  
reception fax: +420 581 277 548  
sales fax: +420 581 701 332

warehouse: +420 581 261 160, 290, 293  
complaints: +420 581 261 281  
GPS: 49.467587°N, 17.448671°E

### Office Prague

EMOS spol. s r.o.  
PB Park, Průmyslová 1306/7  
102 00 Praha 10 – Hostivař



## SLOVAK REPUBLIC

EMOS SK s.r.o.  
Hlinická 409/22  
014 01 Bytča

ID No.: 36392961  
VAT No.: SK2020104834  
e-mail: [emos@emos.sk](mailto:emos@emos.sk)

Sales department: +421 41 50 916 14  
+421 902 96 69 96

Secretariat: +421 41 509 16 11  
Battery repairs: +421 41 509 16 27

## POLAND

EMOS PL Sp. z o.o.  
ul. Gaczyńskiego 6  
43-300 Bielsko-Biała

tel.: +48 33 816 92 42,  
e-mail: [biuro@emos.pl](mailto:biuro@emos.pl)

## SLOVENIA

EMOS SI, d.o.o.  
Rimska cesta 92  
3311 Šempeter v Savinjski dolini

tel.: +386 8 205 17 20  
e-mail: [emos-si@emos-si.si](mailto:emos-si@emos-si.si)

**Croatia | Bosnia and Herzegovina |  
Serbia | Montenegro | North Macedonia**  
Sašo Marinšek  
Managing Director EMOS SI, d.o.o.  
GSM: +386 31 517 364  
e-mail: [marinsek@emos-si.si](mailto:marinsek@emos-si.si)

## HUNGARY

EMOS HU Kft.  
Budaörs Office Park, A épület  
2040 Budaörs, Szabadság út 117

tel.: +36 23 42 80 24  
fax: +36 23 41 42 99  
e-mail: [emos@emos.hu](mailto:emos@emos.hu)

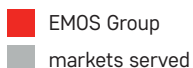

Albania | Austria | Belgium | Bosnia and Herzegovina | Bulgaria | Croatia | Estonia | Finland | France | Germany | Greece | Hungary | Italy | Latvia | Lithuania | Moldova | Montenegro | Netherlands | North Macedonia | Poland | Portugal | Romania | Serbia | Slovakia | Slovenia | Spain | Sweden | Ukraine

## EXPORT

### Export departement + Germany | Austria | Sweden

Ladislav Novak  
Export Manager  
phone: +420 581 261 207  
GSM: +420 724 597 640  
e-mail: [novak@emos.eu](mailto:novak@emos.eu)

### Latvia | Estonia | Lithuania | Finland

Raman Sinevich  
Country Manager  
Baltic countries  
GSM: +371 295 901 79  
e-mail: [sinevich@emos.eu](mailto:sinevich@emos.eu)

### Spain | Portugal | France | Greece | Netherlands | Italy | Denmark | Belgium

Jose Henriquez  
Export Sales Manager  
Phone: +420 581 261 127  
GSM: +420 602 551 726  
e-mail: [henriquez@emos.cz](mailto:henriquez@emos.cz)

### Romania | Bulgaria | Republic of Moldova | Albania

Cseh Szabolcs  
Country Manager  
Baltic countries  
GSM: +40 745 536 783  
e-mail: [cseh@emos.eu](mailto:cseh@emos.eu)



The Eurologistics Centre of EMOS Holding, with an area of over 16,000 m<sup>2</sup>, supports EMOS' strategy to offer its business partners excellent stock availability of products from its product range.

# COMPLETE LIGHTING SERVICE

## Project Implementation

---

### Professionalism

complete and professional service in realising lighting projects

### Effectiveness

we will choose the most suitable solutions and best lights based on the type of building or structure

### Warranty

5-year warranty for our products and reliable measurement of lighting parameters after installation

#### We Will Provide You With

- the most suitable project solution
- calculation of energy demands and costs
- technical documentation
- measurement of lighting parameters after installation

#### Provision of Project Documentation

Ideal documentation for realising a lighting project is a construction project in electronic form (e.g. DWG), or, in the case of simpler structures, a drawing of the room or photo documentation with dimensions.

It is also recommended to provide a description of the space (whether it is, for instance, a shop, production hall, office etc.), its current lighting (if any) and demands for the new lighting.

#### Contact Professionals

Universal: projects@emos.eu  
Czechia: projekty@emos.cz  
Slovakia: projekty@emos.sk  
Poland: projekty@emos.pl  
Slovenia: projekti@emos-si.si  
Hungary: projekttek@emos.hu

[www.emos.eu/lighting](http://www.emos.eu/lighting)



## Services on Offer

### Lighting Calculation

We are able to create a complete custom lighting plan in accordance with valid standards or defined requirements. All our lighting calculations are done exclusively in **Dialux** software. The report includes the results of lighting calculations performed in line with required Czech standards (via point by point method) for individual rooms including calculation of the unified glare rating (for indoor areas), list of luminaires used, their number, dimensioned floor plans of the given space and their normal illuminance, at least one 3D view of the space with drawing of false colours.

### Lighting Measurement

Lighting measurements are made using calibrated measuring instruments. Once the values are measured, we create a measurement report which contains all the information required pursuant to EN 360011 and EN 12464-1 for artificial lighting or to EN 73 0580 for daylighting.

### Calculation of Energy and Financial Return on Investment

The drawn up lighting plan will also be accompanied by a calculation of energy and financial return on investment. We will also help you formulate a compelling business proposal.

EMOS spol. s r.o. is the official partner of DIALux.

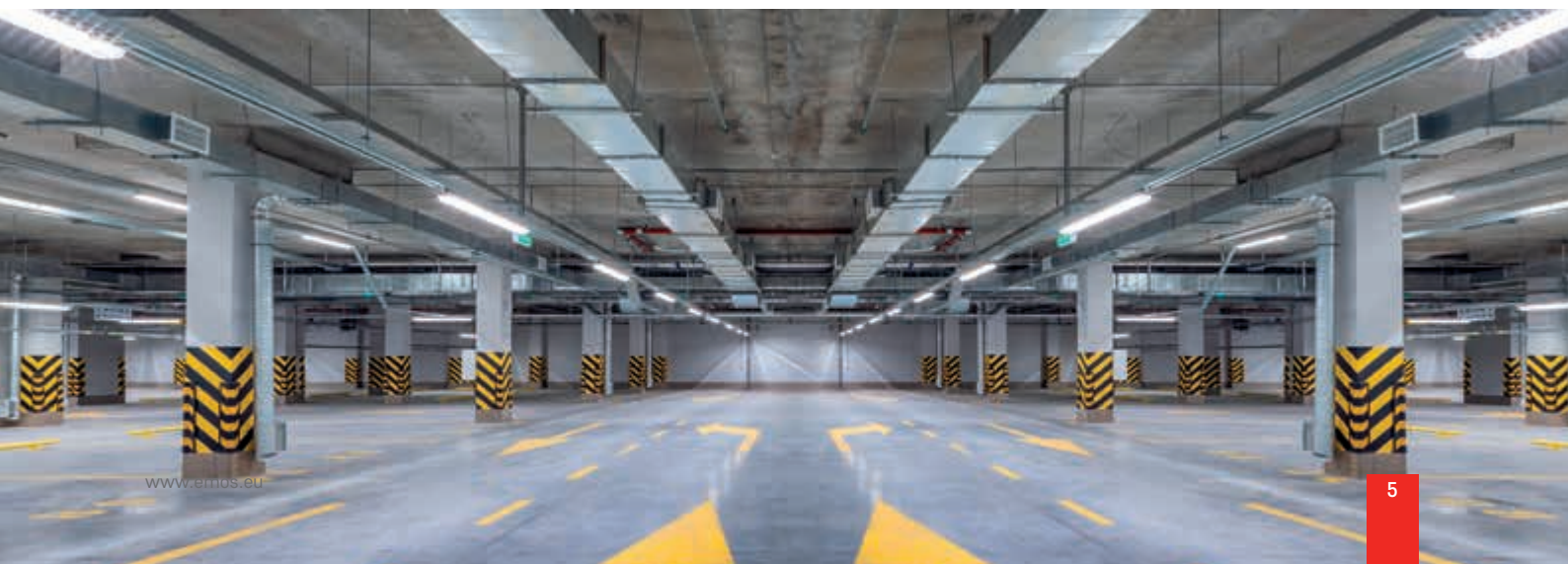

# LED Work Floodlights and LED Floodlights

## LED FLOODLIGHTS

|            |            |   |   |   |  |  |  |  |
|------------|------------|---|---|---|--|--|--|--|
| PROFI PLUS | AGENO      |   |   |   |    |  |  |  |
|            |            | ZS2412  | ZS2422  | ZS2432  | ZS2452   | ZS2462   | ZS2472   |  |
|            |            |   |   |   |  |  | ..... see page 10–11   |  |
|            | PROFI PLUS | ASIMO   |  |  |   |  |  |  |
|            |            |   | ZS1050A   | ZS1100A   | ZS1200A  | ZS1300A  | ..... see page 12–13   |  |
|            |            |   |   |   |  |  |  |  |
|            |            |  |  |  |  |  |  |  |
|            |            | ZS1050B   | ZS1100B   | ZS1200B   | ZS1300B  | ..... see page 14  |  |  |
|            |            |   |   |   |  |  |  |  |
|            |            |  |  |  |  |  |  |  |
|            |            | ZS1050N   | ZS1100N   | ZS1200N   | ZS1300N  | ..... see page 15  |  |  |



## INOVO

PROFI



ZS2612      ZS2622      ZS2632      ZS2642      ZS2652      ZS2662      ZS2672

..... see page 16-17

## INOVO PIR

PROFI



ZS2712      ZS2722      ZS2732      ZS2742

..... see page 18-19

## ILIO

CLASSIC



ZS2510      ZS2520      ZS2530      ZS2540

..... see page 20

## ILIO PIR

CLASSIC



ZS2910      ZS2920      ZS2930      ZS2940

..... see page 21

## TAMBO

CLASSIC



ZS2511      ZS2521      ZS2531      ZS2541

..... see page 22

















## TAMBO PIR

CLASSIC







ZS2911      ZS2921      ZS2931      ZS2941

..... see page 23

|                        |   |   |   |   |                   |
|------------------------|---|---|---|---|-------------------|
| SIMPO<br>ESSENTIAL     |    |    |    |    | ..... see page 24 |
|                        | ZS2213  | ZS2223  | ZS2233  | ZS2243  |                   |
| SIMPO PIR<br>ESSENTIAL |    |    |    |    | ..... see page 25 |
|                        | ZS2212  | ZS2222  | ZS2232  | ZS2242  |                   |
| SIMPO PIR<br>ESSENTIAL |   |   |   |   | ..... see page 26 |
|                        | ZS2313  | ZS2323  | ZS2333  | ZS2343  |                   |
| SIMPO PIR<br>ESSENTIAL |  |  |  |  | ..... see page 27 |
|                        | ZS2312  | ZS2322  | ZS2332  | ZS2342  |                   |

## ACCESSORIES FOR LED FLOODLIGHTS

### ACCESSORIES FOR LED FLOODLIGHTS

|  |  |  |   |
|--|--|--|---|
|     |         |    |  |
| <b>PLASTIC CABLE CONNECTOR</b><br>(I – connector, screw type, 3× 2.5 mm <sup>2</sup> ) | <b>PLASTIC CABLE CONNECTOR</b><br>(I – connector, screwless type, 3× 2.5 mm <sup>2</sup> ) | <b>PLASTIC CABLE CONNECTOR</b><br>(T – connector, screw type, 3× 2.5 mm <sup>2</sup> ) |   |
| ZS9010   | ZS9020   | ZS9030   | ZS9510  |
|  |  |  | ..... see page 28–29  |

# LED WORK FLOODLIGHTS

**CANNO**

**PROFI**

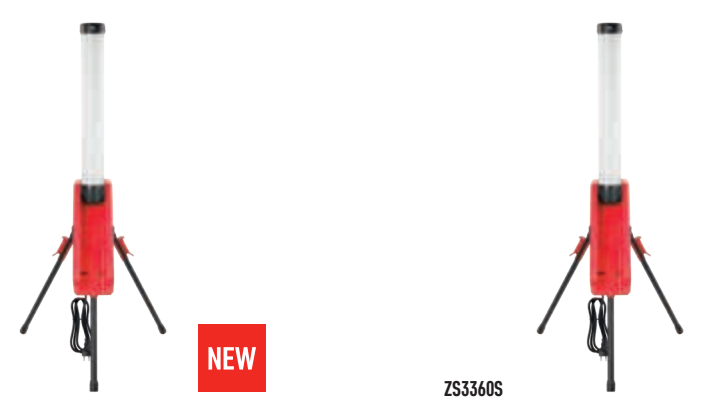

ZS3360F **NEW** ZS3360S **NEW**

..... see page 30

**HOBBY SLIM**

**CLASSIC**

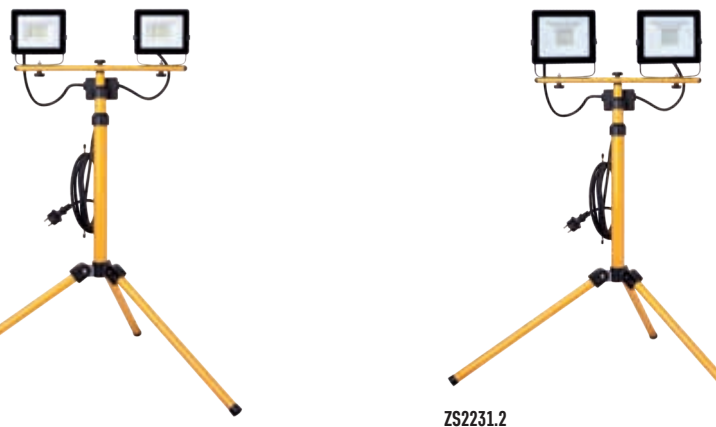

ZS2221.2 ZS2231.2

..... see page 31

**ILIO**

**CLASSIC**



ZS3322 ZS3332 ZS3342

..... see page 32

# LED FLOODLIGHTS WITH ACCUMULATOR

**ACCO**

**CLASSIC**



ZS2812 ZS2822 ZS2832

..... see page 33

# AGENO

LED floodlights AGENO combine top performance with a modern look. The reflectors provide a luminous efficiency of up to 133 lm/W, which is taken care of by PHILIPS LUMILEDS LED chips. The robust and well-made aluminium body can withstand the toughest conditions.

**Main benefits:**

- operating cost savings of up to 95% compared to halogen floodlights
- smoothly dimmable
- adjustable wattage on selected models

**Areas of use:** permanent illumination of indoor and outdoor areas.



Photometric data available at [www.emos.eu/LDT](http://www.emos.eu/LDT)

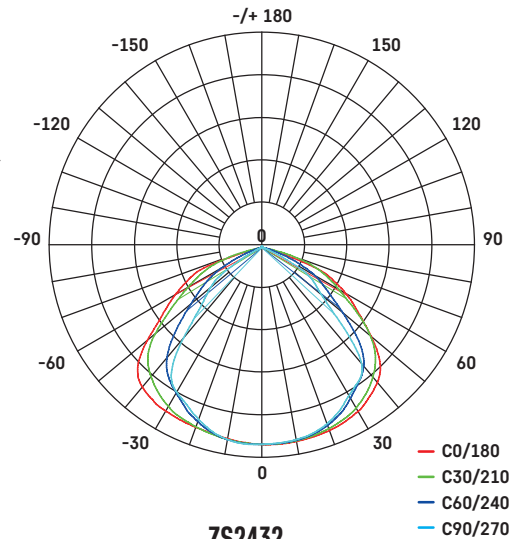

**ZS2412**

1/-/-/10

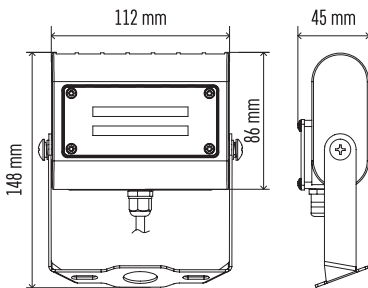

**ZS2422**

1/-/-/10

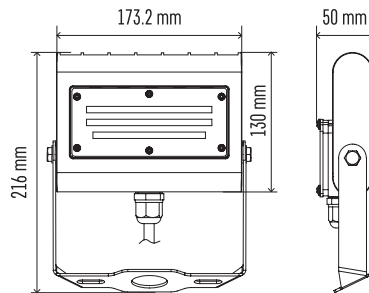

**ZS2432**

1/-/-/6

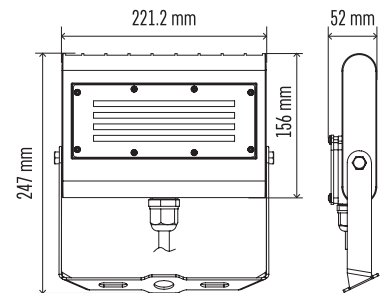

| Type   | EAN           | Power | Luminous Flux | CCT     | PF    | Beam Angle | Luminous Efficacy | Flicker-Free | Dimmable | W × H × D           |
|--------|---------------|-------|---------------|---------|-------|------------|-------------------|--------------|----------|---------------------|
| ZS2412 | 8592920104514 | 15 W  | 1 700 lm      | 4 000 K | > 0.9 | 120 × 90°  | 113 lm/W          | no           | no       | 112 × 86 × 45 mm    |
| ZS2422 | 8592920104538 | 30 W  | 3 500 lm      | 4 000 K | > 0.9 | 120 × 90°  | 117 lm/W          | no           | yes      | 173.2 × 130 × 50 mm |
| ZS2432 | 8592920104552 | 50 W  | 5 700 lm      | 4 000 K | > 0.9 | 120 × 90°  | 114 lm/W          | no           | yes      | 221.2 × 156 × 52 mm |



|                   |              |
|-------------------|--------------|
| Lifetime (L80)    | 50 000 hours |
| CRI               | > 80         |
| Body material     | aluminium    |
| Diffuser material | plastic (PC) |
| IP rating         | IP65         |
| IK                | IK08         |
| Cable length      | 1 m          |



Optional power input  
for ZS2462 (50/80/100/150 W)  
and ZS2472 (150/200/230/300 W)



**ZS2452**

1/-/-1



**ZS2462**

1/-/-1



**ZS2472**

1/-/-1

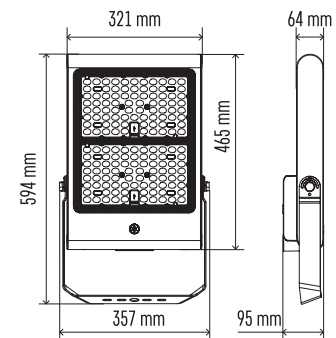
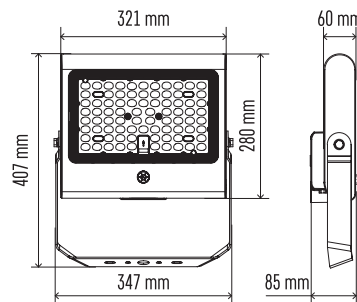
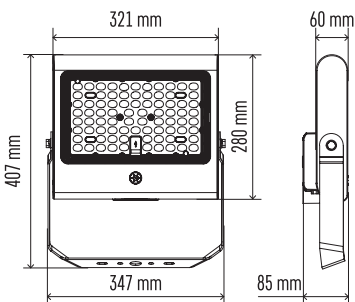

| Type   | EAN           | Power | Luminous Flux | CCT     | PF    | Beam Angle | Luminous Efficacy | Flicker-Free | Dimmable | W × H × D         |
|--------|---------------|-------|---------------|---------|-------|------------|-------------------|--------------|----------|-------------------|
| ZS2452 | 8592920104576 | 100 W | 13 000 lm     | 4 000 K | > 0.9 | 120 × 90°  | 130 lm/W          | yes          | yes      | 321 × 280 × 85 mm |
| ZS2462 | 8592920104583 | 150 W | 20 000 lm     | 4 000 K | > 0.9 | 120 × 90°  | 133 lm/W          | yes          | yes      | 321 × 280 × 85 mm |
| ZS2472 | 8592920104590 | 300 W | 40 000 lm     | 4 000 K | > 0.9 | 120 × 90°  | 133 lm/W          | yes          | yes      | 321 × 465 × 95 mm |

# ASIMO

The durable aluminium floodlights of the ASIMO series in the ASYMMETRIC (A), BILLBOARD (B) and NARROW (N) versions with different beam angles ensure permanent illumination of indoor and outdoor areas. The reflectors are ready to work in extreme weather conditions.

**Main benefits:**

- operating cost savings of up to 70% compared to metal halide and sodium reflectors
- extremely robust body suitable for harsh environments
- light cone shape and width optimised for the specific application

**Areas of use:** permanent illumination of indoor and outdoor areas.





|                   |              |
|-------------------|--------------|
| Lifetime (L80)    | 50 000 hours |
| CRI               | > 80         |
| Body material     | aluminium    |
| Diffuser material | glass        |
| IP rating         | IP66         |
| IK                | IK08         |
| Cable length      | 1 m          |

**5**  
YEARS  
WARRANTY

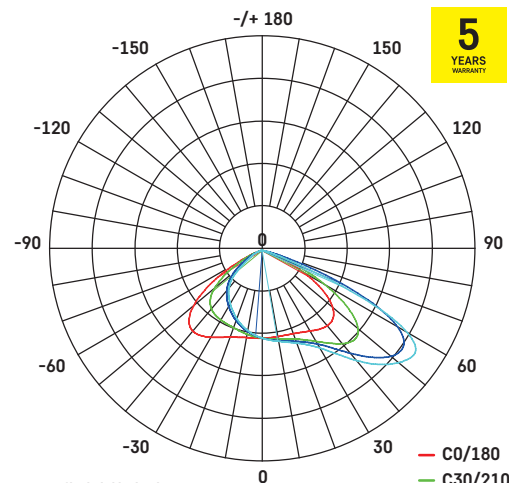

Photometric data available at [www.emos.eu/LDT](http://www.emos.eu/LDT)

**ASYMMETRIC (A)**

- suitable for sports field lighting, industrial areas, driveways
- beam angle 55° × 125°

- C0/180
- C30/210
- C60/240
- C90/270



**ZS1050A**

1/-/-1

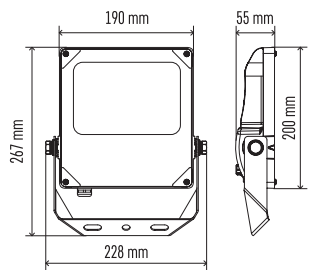

**ZS1100A**

1/-/-1

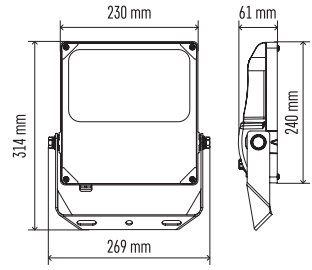

**ZS1200A**

1/-/-1

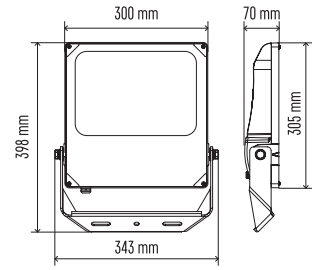

**ZS1300A**

1/-/-1

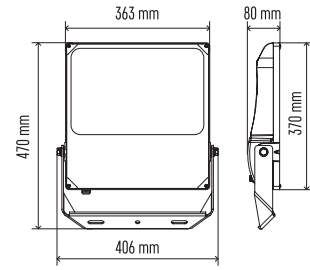

| Type    | EAN           | Power | Luminous Flux | CCT     | PF    | Beam Angle | Luminous Efficacy | Flicker-Free | Dimmable | W × H × D         |
|---------|---------------|-------|---------------|---------|-------|------------|-------------------|--------------|----------|-------------------|
| ZS1050A | 8592920105511 | 50 W  | 5 500 lm      | 4 000 K | > 0.9 | 55 × 125°  | 110 lm/W          | no           | no       | 190 × 200 × 55 mm |
| ZS1100A | 8592920105542 | 100 W | 11 000 lm     | 4 000 K | > 0.9 | 55 × 125°  | 110 lm/W          | yes          | no       | 230 × 240 × 61 mm |
| ZS1200A | 8592920105603 | 200 W | 22 000 lm     | 4 000 K | > 0.9 | 55 × 125°  | 110 lm/W          | yes          | no       | 300 × 305 × 70 mm |
| ZS1300A | 8592920105634 | 300 W | 33 000 lm     | 4 000 K | > 0.9 | 55 × 125°  | 110 lm/W          | yes          | no       | 363 × 370 × 80 mm |

# ASIMO

The durable aluminium floodlights of the ASIMO series in the ASYMMETRIC (A), BILLBOARD (B) and NARROW (N) versions with different beam angles ensure permanent illumination of indoor and outdoor areas. The reflectors are ready to work in extreme weather conditions.

**Main benefits:**

- operating cost savings of up to 70% compared to metal halide and sodium reflectors
- extremely robust body suitable for harsh environments
- light cone shape and width optimised for the specific application

**Areas of use:** permanent illumination of indoor and outdoor areas.

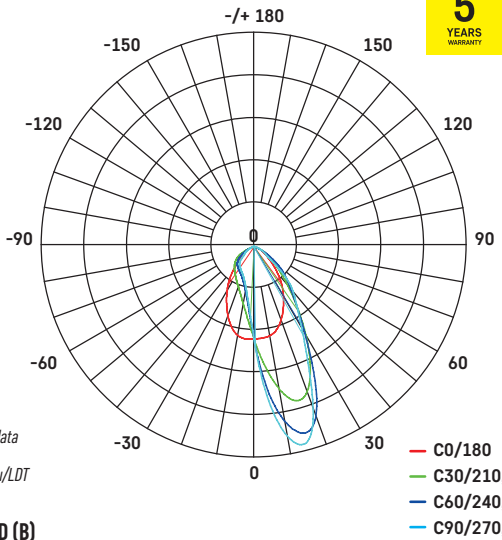

Photometric data available at [www.emos.eu/LDT](http://www.emos.eu/LDT)

**BILLBOARD (B)**

- suitable for illuminating of advertising areas
- beam angle 26° × 60°

**ZS1050B**

1/-/-/1

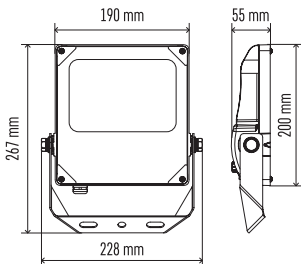

**ZS1100B**

1/-/-/1

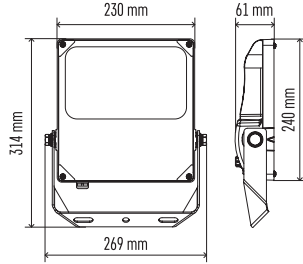

**ZS1200B**

1/-/-/1

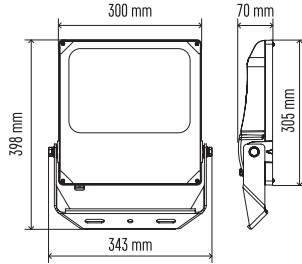

**ZS1300B**

1/-/-/1

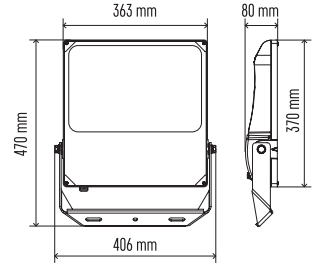

**To order**

| Type    | EAN           | Power | Luminous Flux | CCT     | PF    | Beam Angle | Luminous Efficacy | Flicker-Free | Dimmable | W × H × D         |
|---------|---------------|-------|---------------|---------|-------|------------|-------------------|--------------|----------|-------------------|
| ZS1050B | 8592920105528 | 50 W  | 5 500 lm      | 4 000 K | > 0.9 | 26 × 60°   | 110 lm/W          | no           | no       | 190 × 200 × 55 mm |
| ZS1100B | 8592920105559 | 100 W | 11 000 lm     | 4 000 K | > 0.9 | 26 × 60°   | 110 lm/W          | yes          | no       | 230 × 240 × 61 mm |
| ZS1200B | 8592920105610 | 200 W | 22 000 lm     | 4 000 K | > 0.9 | 26 × 60°   | 110 lm/W          | yes          | no       | 300 × 305 × 70 mm |
| ZS1300B | 8592920105641 | 300 W | 33 000 lm     | 4 000 K | > 0.9 | 26 × 60°   | 110 lm/W          | yes          | no       | 363 × 370 × 80 mm |







|                   |              |
|-------------------|--------------|
| Lifetime (L80)    | 50 000 hours |
| CRI               | > 80         |
| Body material     | aluminium    |
| Diffuser material | glass        |
| IP rating         | IP66         |
| IK                | IK08         |
| Cable length      | 1 m          |

**5**  
YEARS  
WARRANTY



Photometric data available at [www.emos.eu/LDT](http://www.emos.eu/LDT)

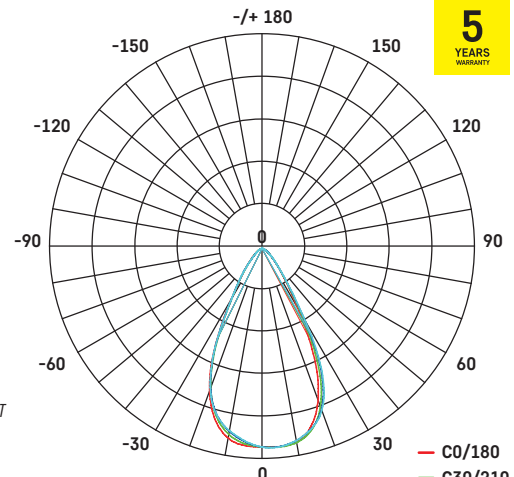

**NARROW (N)**

- suitable for illuminating of building facades
- beam angle 60°

- C0/180
- C30/210
- C60/240
- C90/270



**ZS1050N**

1/-/-/1

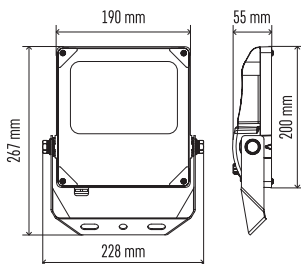

**ZS1100N**

1/-/-/1

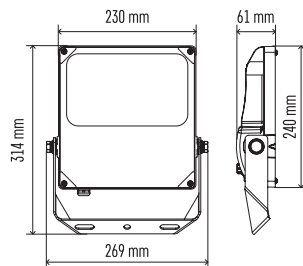

**ZS1200N**

1/-/-/1

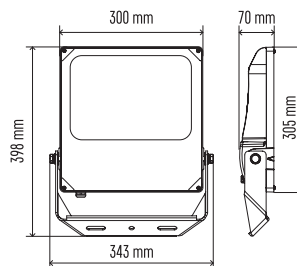

**ZS1300N**

1/-/-/1

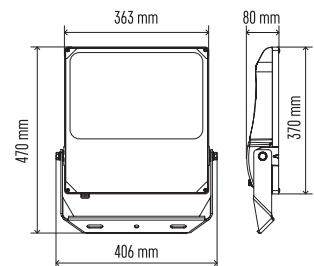

**To order**

| Type    | EAN           | Power | Luminous Flux | CCT     | PF    | Beam Angle | Luminous Efficacy | Flicker-Free | Dimmable | W × H × D         |
|---------|---------------|-------|---------------|---------|-------|------------|-------------------|--------------|----------|-------------------|
| ZS1050N | 8592920105535 | 50 W  | 5 500 lm      | 4 000 K | > 0.9 | 60°        | 110 lm/W          | no           | no       | 190 × 200 × 55 mm |
| ZS1100N | 8592920105566 | 100 W | 11 000 lm     | 4 000 K | > 0.9 | 60°        | 110 lm/W          | yes          | no       | 230 × 240 × 61 mm |
| ZS1200N | 8592920105627 | 200 W | 22 000 lm     | 4 000 K | > 0.9 | 60°        | 110 lm/W          | yes          | no       | 300 × 305 × 70 mm |
| ZS1300N | 8592920105658 | 300 W | 33 000 lm     | 4 000 K | > 0.9 | 60°        | 110 lm/W          | yes          | no       | 363 × 370 × 80 mm |

# INOVO

Light efficiency up to 110 lm/W in combination with absolute reliability and very simple connection make INOVO LED floodlights a bestseller for all installation technicians and hobby users.

## Main benefits:

- operating cost savings of up to 90% compared to halogen spotlights
- professional workmanship for the most demanding conditions
- easy cable connection using the cable connector included in the package

**Areas of use:** permanent illumination of indoor and outdoor areas.



### ZS2612

1/-/-/30

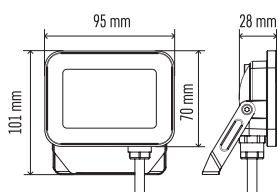

### ZS2622

1/-/-/20

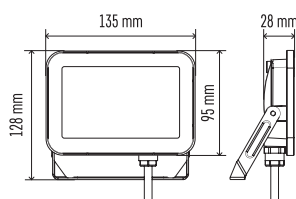

### ZS2632

1/-/-/10



### ZS2642

1/-/-/10

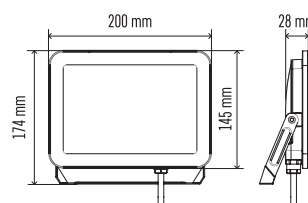

| Type   | EAN           | Power | Luminous Flux | CCT     | PF    | Beam Angle | Luminous Efficacy | W × H × D         |
|--------|---------------|-------|---------------|---------|-------|------------|-------------------|-------------------|
| ZS2612 | 8592920105665 | 10 W  | 1 100 lm      | 4 000 K | > 0.7 | 120°       | 110 lm/W          | 95 × 70 × 28 mm   |
| ZS2622 | 8592920105689 | 20 W  | 2 200 lm      | 4 000 K | > 0.7 | 120°       | 110 lm/W          | 135 × 95 × 28 mm  |
| ZS2632 | 8592920105702 | 30 W  | 3 300 lm      | 4 000 K | > 0.9 | 120°       | 110 lm/W          | 160 × 110 × 28 mm |
| ZS2642 | 8592920105726 | 50 W  | 5 500 lm      | 4 000 K | > 0.9 | 120°       | 110 lm/W          | 200 × 145 × 28 mm |



|                   |              |
|-------------------|--------------|
| Lifetime (L80)    | 50 000 hours |
| CRI               | > 80         |
| Body material     | aluminium    |
| Diffuser material | glass        |
| IP rating         | IP65         |
| IK                | IK07         |
| Cable length      | 30 cm        |

**5**  
YEARS  
WARRANTY

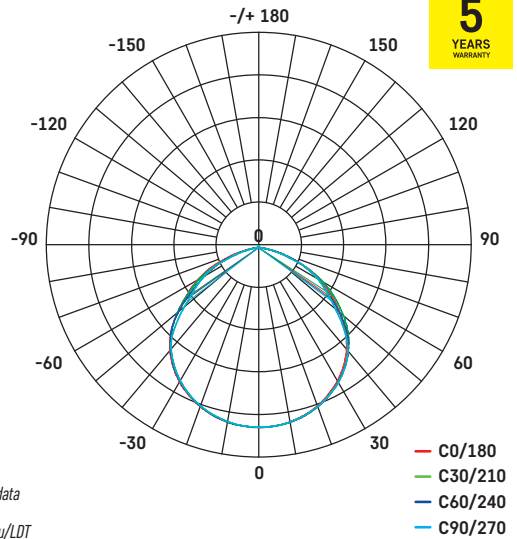

**ZS2652**

1/-/-/5

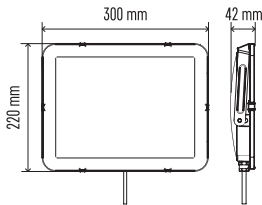

**ZS2662**

1/-/-/3

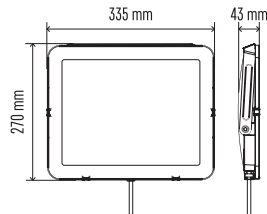

**ZS2672**

1/-/-/2

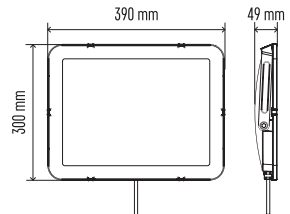

| Type   | EAN           | Power | Luminous Flux | CCT     | PF    | Beam Angle | Luminous Efficacy | W × H × D         |
|--------|---------------|-------|---------------|---------|-------|------------|-------------------|-------------------|
| ZS2652 | 8592920105740 | 100 W | 11 000 lm     | 4 000 K | > 0.9 | 120°       | 110 lm/W          | 300 × 220 × 42 mm |
| ZS2662 | 8592920105764 | 150 W | 16 500 lm     | 4 000 K | > 0.9 | 120°       | 110 lm/W          | 335 × 270 × 43 mm |
| ZS2672 | 8592920105788 | 200 W | 22 000 lm     | 4 000 K | > 0.9 | 120°       | 110 lm/W          | 390 × 300 × 49 mm |

# INOVO PIR

A luminous efficiency of up to 100 lm/W combined with absolute reliability and very simple connection make the INOVO PIR LED floodlights a bestseller for all installation technicians and hobby users. The floodlights are equipped with a motion sensor with dimming and run time adjustment.

## Main benefits:

- operating cost savings of up to 90% compared to halogen spotlights
- professional workmanship for the most demanding conditions
- simple cable connection to the terminal block

**Areas of use:** permanent illumination of indoor and outdoor areas.



## ZS2712

1/-/-/20

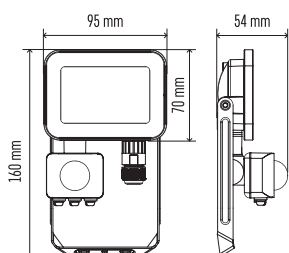

## ZS2722

1/-/-/20

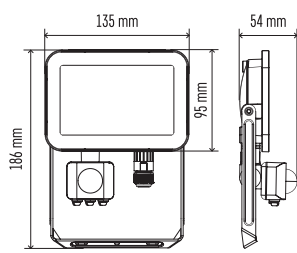

## ZS2732

1/-/-/10

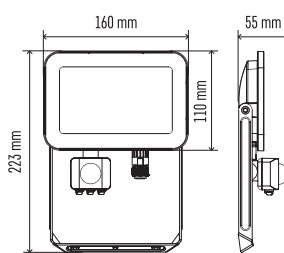

## ZS2742

1/-/-/10

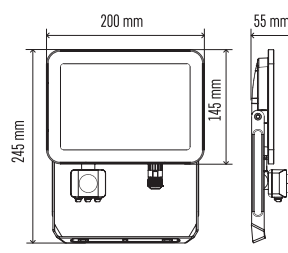

| Type   | EAN           | Power | Luminous Flux | CCT     | PF    | Beam Angle | Luminous Efficacy | Detection Angle | Detection Range | Time Setting                       | W × H × D         |
|--------|---------------|-------|---------------|---------|-------|------------|-------------------|-----------------|-----------------|------------------------------------|-------------------|
| ZS2712 | 8592920105801 | 10 W  | 1 100 lm      | 4 000 K | > 0,7 | 120°       | 110 lm/W          | 120°            | 10 m            | min. 10 s ±3 s - max. 7 min ±2 min | 95 × 70 × 54 mm   |
| ZS2722 | 8592920105825 | 20 W  | 2 200 lm      | 4 000 K | > 0,7 | 120°       | 110 lm/W          | 120°            | 10 m            | min. 10 s ±3 s - max. 7 min ±2 min | 135 × 95 × 54 mm  |
| ZS2732 | 8592920105832 | 30 W  | 3 300 lm      | 4 000 K | > 0,9 | 120°       | 110 lm/W          | 120°            | 10 m            | min. 10 s ±3 s - max. 7 min ±2 min | 160 × 110 × 55 mm |
| ZS2742 | 8592920105849 | 50 W  | 5 500 lm      | 4 000 K | > 0,9 | 120°       | 110 lm/W          | 120°            | 10 m            | min. 10 s ±3 s - max. 7 min ±2 min | 200 × 145 × 55 mm |

|                   |              |
|-------------------|--------------|
| Lifetime (L80)    | 50 000 hours |
| CRI               | > 80         |
| Body material     | aluminium    |
| Diffuser material | glass        |
| IP rating         | IP65         |
| IK                | IK06         |
| Cable length      | 30 cm        |



Photometric data  
available at  
[www.emos.eu/LDT](http://www.emos.eu/LDT)

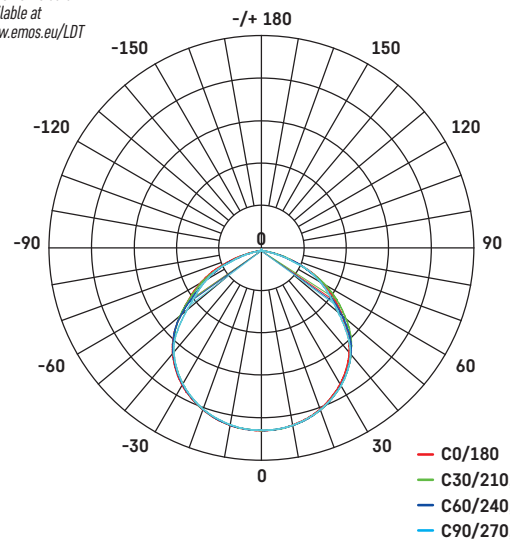

# ILIO

ILIO LED floodlights offer a unique design with a milky PC diffuser, which ensures a perfectly symmetrical light distribution in the illuminated space.

**Main benefits:**

- operating cost savings of up to 90% compared to halogen spotlights
- IP65 protection guarantees water resistance
- easy cable connection to the terminal block

**Areas of use:** facade lighting, lighting in private and public spaces, illumination of sales and exhibition stands.

|                   |              |
|-------------------|--------------|
| Lifetime (L80)    | 25 000 hours |
| CRI               | > 80         |
| Body material     | aluminium    |
| Diffuser material | plastic (PC) |
| IP rating         | IP65         |
| IK                | IK08         |



Photometric data available at [www.emos.eu/LDT](http://www.emos.eu/LDT)

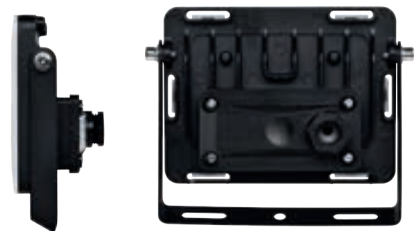
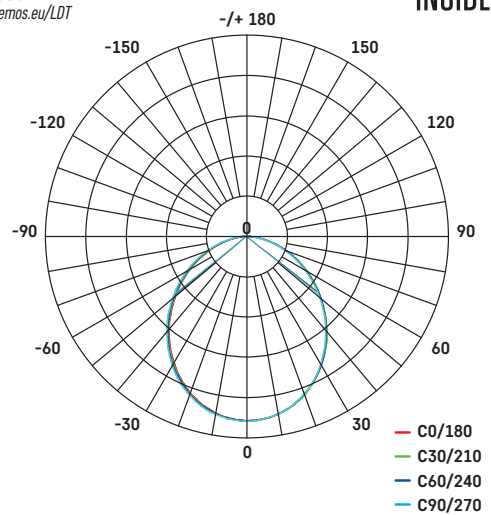

**ZS2510**

1/-/-20

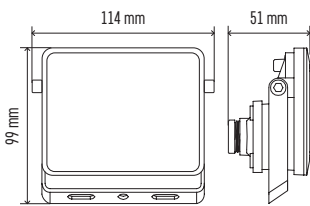

**ZS2520**

1/-/-20

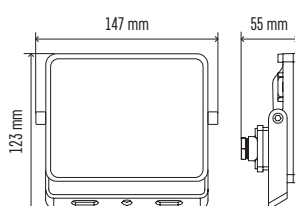

**ZS2530**

1/-/-12

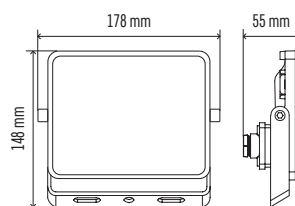

**ZS2540**

1/-/-10

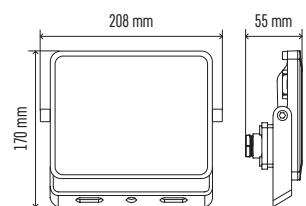

| Type   | EAN           | Power  | Luminous Flux | CCT     | PF    | Beam Angle | Luminous Efficacy | W × H × D         |
|--------|---------------|--------|---------------|---------|-------|------------|-------------------|-------------------|
| ZS2510 | 8592920081495 | 10,5 W | 950 lm        | 4 000 K | > 0.9 | 120°       | 90 lm/W           | 114 × 99 × 51 mm  |
| ZS2520 | 8592920081518 | 21 W   | 1 900 lm      | 4 000 K | > 0.9 | 120°       | 90 lm/W           | 147 × 123 × 55 mm |
| ZS2530 | 8592920081532 | 31 W   | 2 800 lm      | 4 000 K | > 0.9 | 120°       | 90 lm/W           | 178 × 148 × 55 mm |
| ZS2540 | 8592920081556 | 51 W   | 4 600 lm      | 4 000 K | > 0.9 | 120°       | 90 lm/W           | 208 × 170 × 55 mm |

## ILIO PIR

ILIO PIR floodlights are fitted with a motion sensor and allow the user to set the luminaire's daylight sensor and lighting duration after sensor activation.

### Main benefits:

- operating cost savings of up to 90% compared to halogen spotlights
- IP44 protection guarantees water resistance
- easy cable connection to the terminal block

**Areas of use:** illumination of private and commercial spaces.

|                   |              |
|-------------------|--------------|
| Lifetime (L80)    | 25 000 hours |
| CRI               | > 80         |
| Body material     | aluminium    |
| Diffuser material | plastic (PC) |
| IP rating         | IP44         |
| IK                | IK06         |



Photometric data available at [www.emos.eu/LDT](http://www.emos.eu/LDT)

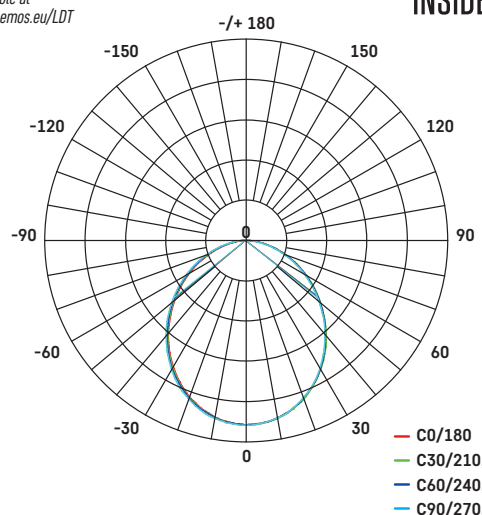

### ZS2910

1/-/-18

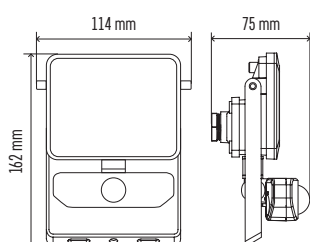

### ZS2920

1/-/-12

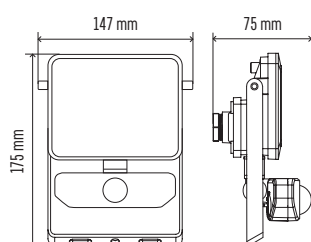

### ZS2930

1/-/-10

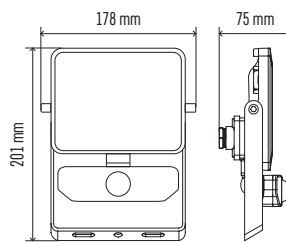

### ZS2940

1/-/-5

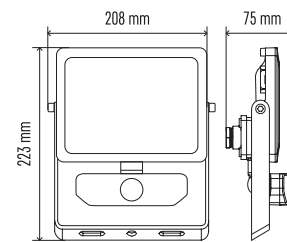

| Type   | EAN           | Power  | Luminous Flux | CCT     | PF    | Beam Angle | Luminous Efficacy | Detection Angle | Detection Range | Time Setting                        | W × H × D         |
|--------|---------------|--------|---------------|---------|-------|------------|-------------------|-----------------|-----------------|-------------------------------------|-------------------|
| ZS2910 | 8592920081570 | 10.5 W | 950 lm        | 4 000 K | > 0.9 | 120°       | 90 lm/W           | 120°            | 10 m            | min. 10 s ±5 s – max. 10 min ±1 min | 114 × 162 × 75 mm |
| ZS2920 | 8592920081792 | 21 W   | 1 900 lm      | 4 000 K | > 0.9 | 120°       | 90 lm/W           | 120°            | 10 m            | min. 10 s ±5 s – max. 10 min ±1 min | 147 × 175 × 75 mm |
| ZS2930 | 8592920081594 | 31 W   | 2 800 lm      | 4 000 K | > 0.9 | 120°       | 90 lm/W           | 120°            | 10 m            | min. 10 s ±5 s – max. 10 min ±1 min | 178 × 201 × 75 mm |
| ZS2940 | 8592920081617 | 50 W   | 4 000 lm      | 4 000 K | > 0.9 | 120°       | 90 lm/W           | 120°            | 10 m            | min. 10 s ±5 s – max. 10 min ±1 min | 208 × 223 × 75 mm |

# TAMBO

TAMBO LED floodlights in an ultra-slim design are made of aluminium with a milky PC diffuser for a pleasantly diffused light.

**Main benefits:**

- operating cost savings of up to 90% compared to halogen spotlights
- IP65 protection guarantees water resistance
- ultra-thin design

**Areas of use:** undemanding applications in commercial and private spaces and their surroundings.

|                   |              |
|-------------------|--------------|
| Lifetime (L80)    | 25 000 hours |
| CRI               | > 80         |
| Body material     | aluminium    |
| Diffuser material | plastic (PC) |
| IP rating         | IP65         |
| IK                | IK08         |
| Cable length      | 30 cm        |



Photometric data available at [www.emos.eu/LDT](http://www.emos.eu/LDT)

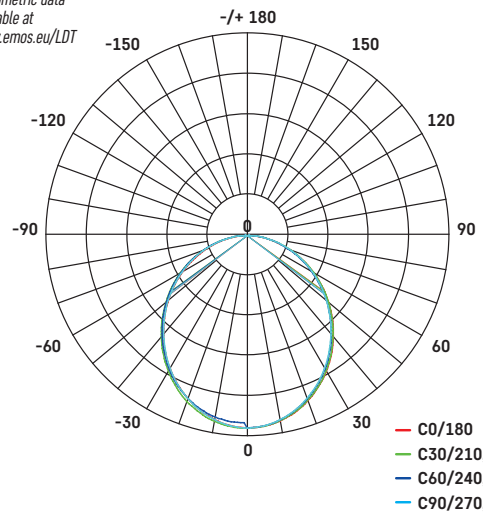

**ZS2511**

1/-/-14

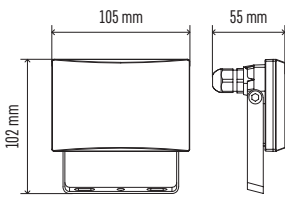

**ZS2521**

1/-/-12

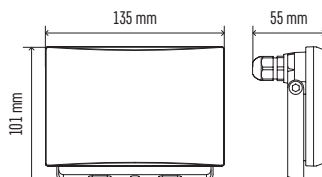

**ZS2531**

1/-/-10

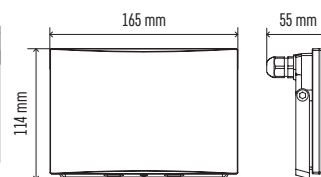

**ZS2541**

1/-/-7

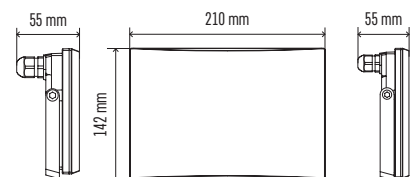

| Type   | EAN           | Power  | Luminous Flux | CCT     | PF    | Beam Angle | Luminous Efficacy | W × H × D         |
|--------|---------------|--------|---------------|---------|-------|------------|-------------------|-------------------|
| ZS2511 | 8592920081631 | 10.5 W | 800 lm        | 4 000 K | > 0.9 | 120°       | 80 lm/W           | 105 × 102 × 55 mm |
| ZS2521 | 8592920081655 | 20 W   | 1 600 lm      | 4 000 K | > 0.9 | 120°       | 80 lm/W           | 135 × 101 × 55 mm |
| ZS2531 | 8592920081679 | 30.5 W | 2 600 lm      | 4 000 K | > 0.9 | 120°       | 80 lm/W           | 165 × 114 × 55 mm |
| ZS2541 | 8592920081693 | 51 W   | 4 300 lm      | 4 000 K | > 0.9 | 120°       | 80 lm/W           | 210 × 142 × 55 mm |



## TAMBO PIR

TAMBO PIR LED floodlights are equipped with a motion sensor with the possibility of setting the dimming sensor and the operation time after switching on.

### Main benefits:

- operating cost savings of up to 90% compared to halogen spotlights
- IP54 protection guarantees water resistance
- ultra-thin design

**Areas of use:** undemanding applications in commercial and private spaces and their surroundings.



|                   |              |
|-------------------|--------------|
| Lifetime (L80)    | 25 000 hours |
| CRI               | > 80         |
| Body material     | aluminium    |
| Diffuser material | plastic (PC) |
| IP rating         | IP54         |
| IK                | IK06         |
| Cable length      | 30 cm        |



Photometric data available at [www.emos.eu/LDT](http://www.emos.eu/LDT)

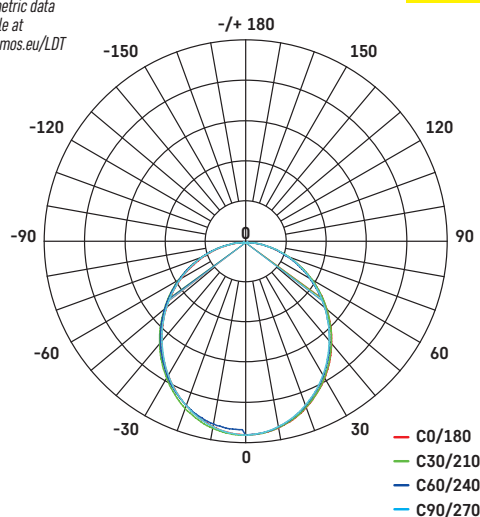

### ZS2911

1/-/-/14

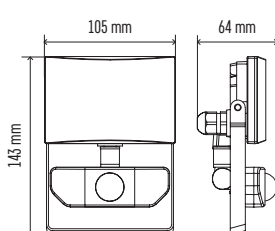

### ZS2921

1/-/-/12

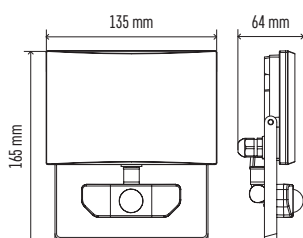

### ZS2931

1/-/-/10

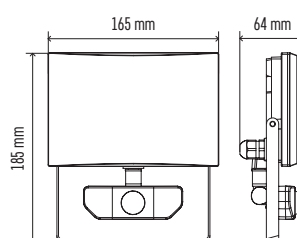

### ZS2941

1/-/-/7

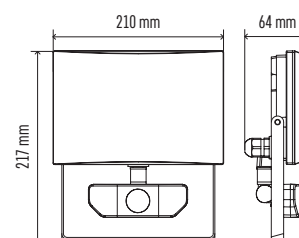

| Type   | EAN           | Power  | Luminous Flux | CCT     | PF    | Beam Angle | Luminous Efficacy | Detection Angle | Detection Range | Time Setting                        | W × H × D         |
|--------|---------------|--------|---------------|---------|-------|------------|-------------------|-----------------|-----------------|-------------------------------------|-------------------|
| ZS2911 | 8592920081716 | 10.5 W | 800 lm        | 4 000 K | > 0.9 | 120°       | 80 lm/W           | 120°            | 10 m            | min. 10 s ±5 s – max. 10 min ±1 min | 105 × 143 × 64 mm |
| ZS2921 | 8592920081730 | 20 W   | 1 600 lm      | 4 000 K | > 0.9 | 120°       | 80 lm/W           | 120°            | 10 m            | min. 10 s ±5 s – max. 10 min ±1 min | 135 × 165 × 64 mm |
| ZS2931 | 8592920081754 | 30.5 W | 2 600 lm      | 4 000 K | > 0.9 | 120°       | 80 lm/W           | 120°            | 10 m            | min. 10 s ±5 s – max. 10 min ±1 min | 165 × 185 × 64 mm |
| ZS2941 | 8592920081778 | 51 W   | 4 300 lm      | 4 000 K | > 0.9 | 120°       | 80 lm/W           | 120°            | 10 m            | min. 10 s ±5 s – max. 10 min ±1 min | 210 × 217 × 64 mm |

# SIMPO

SIMPO LED floodlights in an ultra-slim classic design are made of aluminium with a glass diffuser to ensure good lighting conditions.

**Main benefits:**

- operating cost savings of up to 90% compared to halogen spotlights
- IP65 protection guarantees water resistance
- ultra-thin design

**Areas of use:** undemanding applications in private spaces and their surroundings.

|                   |              |
|-------------------|--------------|
| Lifetime (L80)    | 25 000 hours |
| CRI               | > 80         |
| Body material     | aluminium    |
| Diffuser material | glass        |
| IP rating         | IP65         |
| Cable length      | 20 cm        |



Photometric data available at [www.emos.eu/LDT](http://www.emos.eu/LDT)

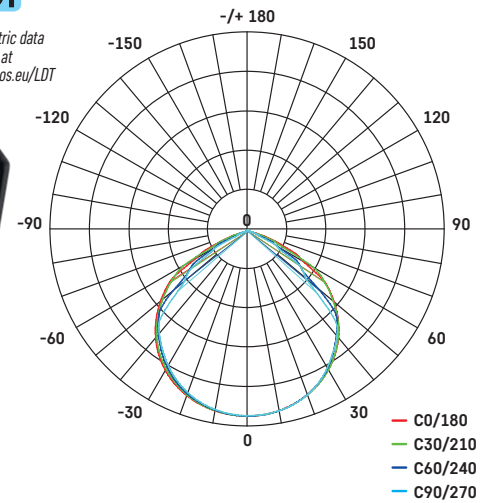

**ZS2213**

1/-/-/48



**ZS2223**

1/-/-/24



**ZS2233**

1/-/-/24



**ZS2243**

1/-/-/12

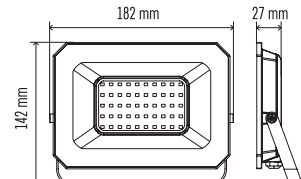
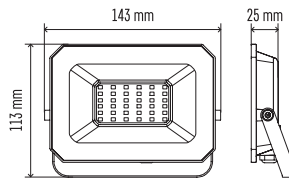
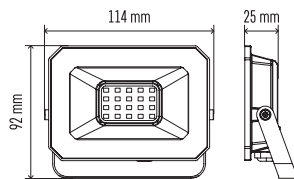
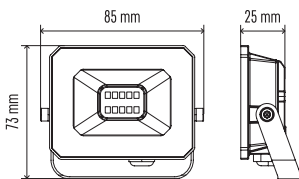

| Type   | EAN           | Power | Luminous Flux | CCT     | PF    | Beam Angle | Luminous Efficacy | W × H × D         |
|--------|---------------|-------|---------------|---------|-------|------------|-------------------|-------------------|
| ZS2213 | 8592920120286 | 10 W  | 1 000 lm      | 4 000 K | > 0.5 | 120°       | 100 lm/W          | 85 × 73 × 25 mm   |
| ZS2223 | 8592920120309 | 20 W  | 2 000 lm      | 4 000 K | > 0.7 | 120°       | 100 lm/W          | 114 × 92 × 25 mm  |
| ZS2233 | 8592920120323 | 30 W  | 3 000 lm      | 4 000 K | > 0.9 | 120°       | 100 lm/W          | 143 × 113 × 25 mm |
| ZS2243 | 8592920120347 | 50 W  | 5 000 lm      | 4 000 K | > 0.9 | 120°       | 100 lm/W          | 182 × 142 × 27 mm |



|                   |              |
|-------------------|--------------|
| Lifetime (L80)    | 20 000 hours |
| CRI               | > 80         |
| Body material     | aluminium    |
| Diffuser material | glass        |
| IP rating         | IP65         |
| Cable length      | 20 cm        |



Photometric data available at [www.emos.eu/LDT](http://www.emos.eu/LDT)

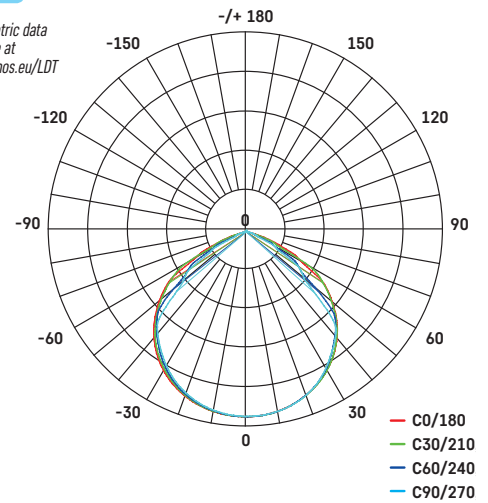

**ZS2212**

1/-/-/30

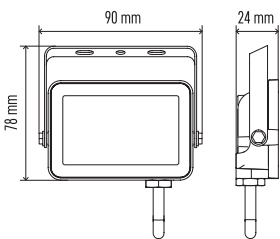

**ZS2222**

1/-/-/30

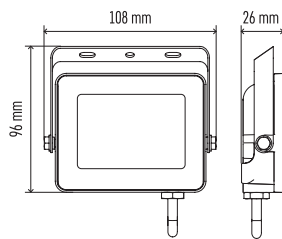

**ZS2232**

1/-/-/20

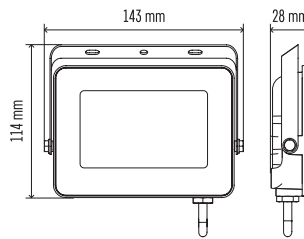

**ZS2242**

1/-/-/20

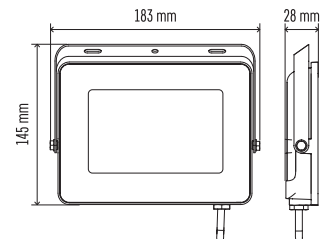

| Type   | EAN           | Power  | Luminous Flux | CCT     | PF    | Beam Angle | Luminous Efficacy | W × H × D         |
|--------|---------------|--------|---------------|---------|-------|------------|-------------------|-------------------|
| ZS2212 | 8592920110225 | 10.5 W | 900 lm        | 4 000 K | > 0.9 | 110°       | 85 lm/W           | 90 × 78 × 24 mm   |
| ZS2222 | 8592920110249 | 20.5 W | 1 800 lm      | 4 000 K | > 0.9 | 110°       | 85 lm/W           | 108 × 96 × 26 mm  |
| ZS2232 | 8592920110263 | 30 W   | 2 700 lm      | 4 000 K | > 0.9 | 110°       | 85 lm/W           | 143 × 114 × 28 mm |
| ZS2242 | 8592920110287 | 50 W   | 4 500 lm      | 4 000 K | > 0.9 | 110°       | 85 lm/W           | 183 × 146 × 28 mm |

# SIMPO PIR

SIMPO PIR LED floodlights are equipped with a motion sensor with the possibility of setting the dimming sensor and operation time after switching on.

**Main benefits:**

- operating cost savings of up to 90% compared to halogen spotlights
- IP44 protection ensures water resistance
- ultra-thin design

**Areas of use:** undemanding applications in private spaces and their surroundings.

|                   |              |
|-------------------|--------------|
| Lifetime (L80)    | 25 000 hours |
| CRI               | > 80         |
| Body material     | aluminium    |
| Diffuser material | glass        |
| IP rating         | IP44         |
| Cable length      | 20 cm        |



Photometric data available at [www.emos.eu/LDT](http://www.emos.eu/LDT)

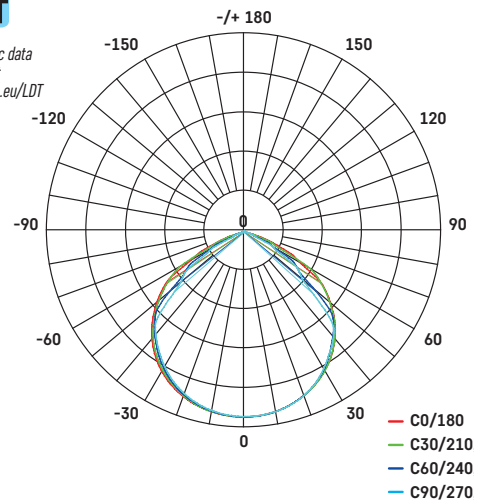

**ZS2313**

1/-/-/16



**ZS2323**

1/-/-/20



**ZS2333**

1/-/-/10



**ZS2343**

1/-/-/10

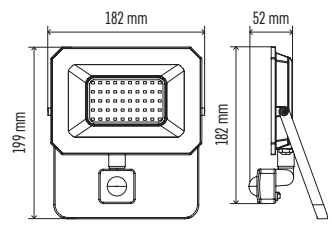
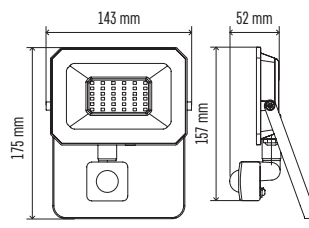
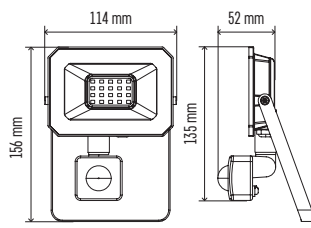
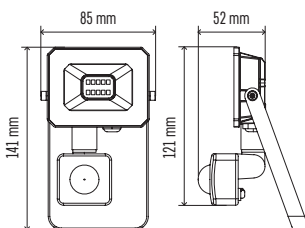

| Type   | EAN           | Power | Luminous Flux | CCT     | PF    | Beam Angle | Luminous Efficacy | Detection Angle | Detection Range | Time Setting                          | W × H × D         |
|--------|---------------|-------|---------------|---------|-------|------------|-------------------|-----------------|-----------------|---------------------------------------|-------------------|
| ZS2313 | 8592920120361 | 10 W  | 1 000 lm      | 4 000 K | > 0.5 | 120°       | 100 lm/W          | 120°            | 8 m             | min. 10 s ± 5 s - max. 10 min ± 1 min | 85 × 141 × 52 mm  |
| ZS2323 | 8592920120385 | 20 W  | 2 000 lm      | 4 000 K | > 0.7 | 120°       | 100 lm/W          | 120°            | 8 m             | min. 10 s ± 5 s - max. 10 min ± 1 min | 114 × 156 × 52 mm |
| ZS2333 | 8592920120408 | 30 W  | 3 000 lm      | 4 000 K | > 0.9 | 120°       | 100 lm/W          | 120°            | 8 m             | min. 10 s ± 5 s - max. 10 min ± 1 min | 143 × 175 × 52 mm |
| ZS2343 | 8592920120422 | 50 W  | 5 000 lm      | 4 000 K | > 0.9 | 120°       | 100 lm/W          | 120°            | 8 m             | min. 10 s ± 5 s - max. 10 min ± 1 min | 182 × 199 × 52 mm |



|                   |              |
|-------------------|--------------|
| Lifetime (L80)    | 20 000 hours |
| CRI               | > 80         |
| Body material     | aluminium    |
| Diffuser material | glass        |
| IP rating         | IP44         |
| Cable length      | 20 cm        |



Photometric data available at [www.emos.eu/LDT](http://www.emos.eu/LDT)

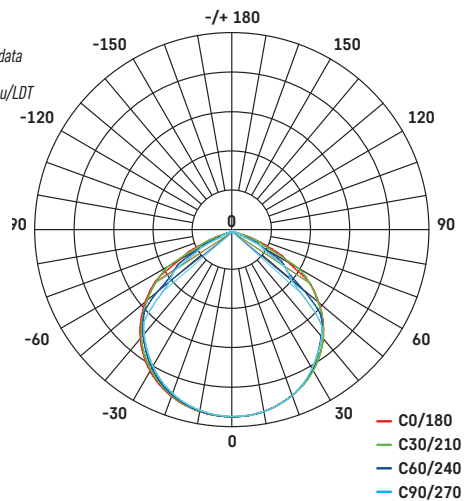

**ZS2312**

1/-/-15

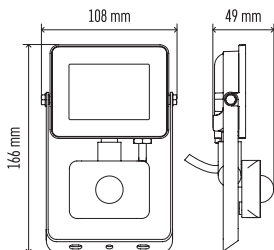

**ZS2322**

1/-/-15

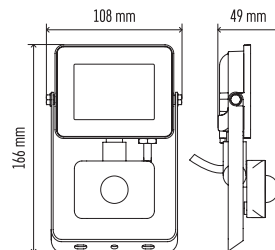

**ZS2332**

1/-/-10

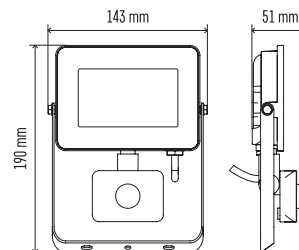

**ZS2342**

1/-/-10

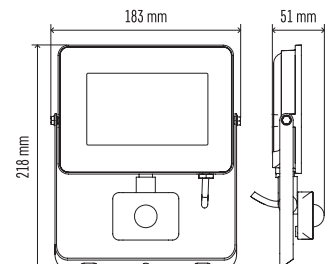

| Type   | EAN           | Power  | Luminous Flux | CCT     | PF    | Beam Angle | Luminous Efficacy | Detection Angle | Detection Range | Time Setting                        | W × H × D         |
|--------|---------------|--------|---------------|---------|-------|------------|-------------------|-----------------|-----------------|-------------------------------------|-------------------|
| ZS2312 | 8592920110300 | 10.5 W | 900 lm        | 4 000 K | > 0.9 | 110°       | 85 lm/W           | 120°            | 8 m             | min. 10 s ±5 s - max. 10 min ±1 min | 108 × 166 × 49 mm |
| ZS2322 | 8592920110324 | 20.5 W | 1 800 lm      | 4 000 K | > 0.9 | 110°       | 85 lm/W           | 120°            | 8 m             | min. 10 s ±5 s - max. 10 min ±1 min | 108 × 166 × 49 mm |
| ZS2332 | 8592920110348 | 30 W   | 2 700 lm      | 4 000 K | > 0.9 | 110°       | 85 lm/W           | 120°            | 8 m             | min. 10 s ±5 s - max. 10 min ±1 min | 143 × 190 × 51 mm |
| ZS2342 | 8592920110362 | 50 W   | 4 500 lm      | 4 000 K | > 0.9 | 110°       | 85 lm/W           | 120°            | 8 m             | min. 10 s ±5 s - max. 10 min ±1 min | 183 × 218 × 51 mm |

# THE ACCESSORIES FOR LED FLOODLIGHTS

In the accessories for LED floodlights we mainly offer plastic cable connectors used for easy connection of two or more three-core conductors as well as stands for mounting LED floodlights.



**ZS9010**

1/-/10/90



**ZS9020**

1/-/10/90



**ZS9030**

1/-/10/80

| Type   | EAN           | Item Name   | IP Rating | Diameter                    |
|--------|---------------|---|-----------|-----------------------------|
| ZS9010 | 8592920031919 | I – connector, screw type, 3× 2.5 mm <sup>2</sup>     | IP68      | 3× 0.75–2.5 mm <sup>2</sup> |
| ZS9020 | 8592920087718 | I – connector, screwless type, 3× 2.5 mm <sup>2</sup> | IP68      | 3× 0.75–2.5 mm <sup>2</sup> |
| ZS9030 | 8592920087749 | T – connector, screw type, 3× 2.5 mm <sup>2</sup>     | IP68      | 3× 0.75–2.5 mm <sup>2</sup> |



**ZS9510**

1/-/-/4

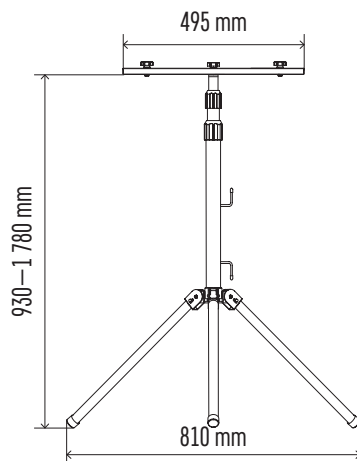

| Type   | EAN           | Item Name                  | Load Limit | W × H × D               |
|--------|---------------|----------------------------|------------|-------------------------|
| ZS9510 | 8592920035160 | Tripod for Two Floodlights | max. 4 kg  | 495 × 930–1780 × 810 mm |

**EMOS**<sup>®</sup>

A brand of **legrand**



# CANNO

LED work lights CANNO emit light in all directions and perfectly illuminate the work area. Great fit for non-static work in both indoor and outdoor environments. The ingenious folding design makes transport easy and the integrated go-through socket allows connection of multiple luminaires in a row.

### Main benefits:

- 360° beam angle
- foldable design for easy and quick transport
- high efficiency

**Areas of use:** lighting of workplaces on construction sites, at family houses, in garages, workshops, car repair shops.

|                   |               |
|-------------------|---------------|
| Lifetime          | 30 000 hours  |
| CRI               | > 80          |
| Body material     | plastic (ABS) |
| Diffuser material | plastic (PC)  |
| IP rating         | IP54          |
| IK                | IK07          |
| Cable length      | 2.5 m         |

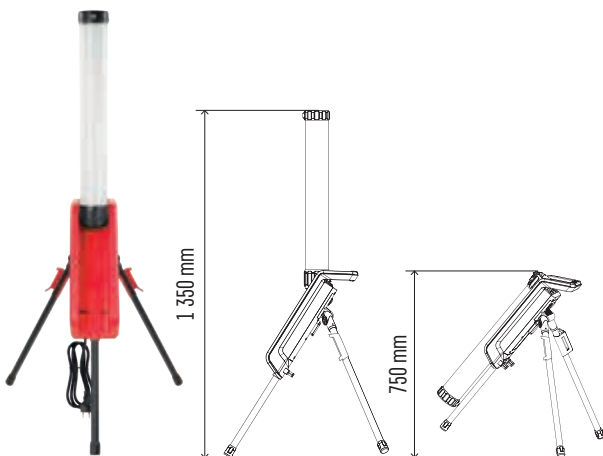

**ZS3360F**

☐ 1/-/-1

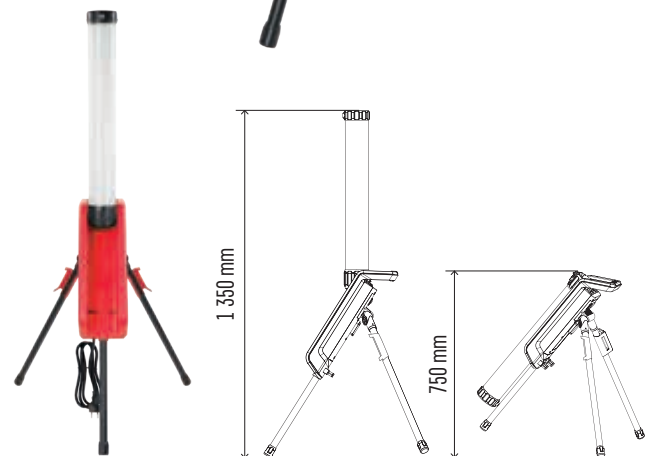

**ZS3360S**

☐ 1/-/-1

| Type    | EAN           | Variant | Power | Luminous Flux | CCT     | PF    | W × H × D          |
|---------|---------------|---------|-------|---------------|---------|-------|--------------------|
| ZS3360F | 8592920120521 | French  | 70 W  | 7 000 lm      | 4 000 K | > 0.9 | 205 × 880 × 160 mm |
| ZS3360S | 8592920120545 | Schuko  | 70 W  | 7 000 lm      | 4 000 K | > 0.9 | 205 × 880 × 160 mm |



# HOBBY SLIM

LED floodlights on tripods of the HOBBY SLIM series are suitable for indoor and outdoor lighting thanks to their higher coverage. They can withstand rough handling, survive lower outdoor temperatures or water drops, and with the help of a stand you can adjust the direction of their light where it is needed.

**Main benefits:**

- height adjustable up to 185 cm
- IP65 waterproof

**Areas of use:** lighting of workplaces on construction sites, at family houses, in garages, workshops, car repair shops

|                   |              |
|-------------------|--------------|
| Lifetime          | 25 000 hours |
| CRI               | > 80         |
| Body material     | aluminium    |
| Diffuser material | glass        |
| IP rating         | IP65         |
| IK                | IK08         |
| Cable length      | 3 m          |

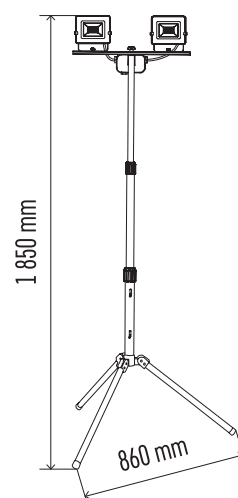
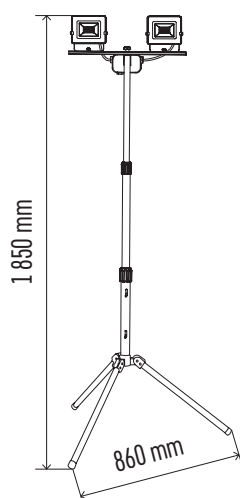

**ZS2221.2**

1/-/-2

**ZS2231.2**

1/-/-2

| Type     | EAN           | Power     | Luminous Flux | CCT     | PF    | W × H × D            |
|----------|---------------|-----------|---------------|---------|-------|----------------------|
| ZS2221.2 | 8592920067543 | 2× 20.5 W | 2× 1 600 lm   | 4 000 K | > 0.5 | 860 × 1 850 × 860 mm |
| ZS2231.2 | 8592920067567 | 2× 30 W   | 2× 2 400 lm   | 4 000 K | > 0.5 | 860 × 1 850 × 860 mm |

# ILIO

The ILIO series of portable LED work lights are mains powered and suitable for indoor and outdoor use. They are suitable for working in harsh environments thanks to their robust construction which is shockproof and waterproof.

**Main benefits:**

- wide area illumination angle of 110°
- water and impact resistance due to IP44 and IK10 protection
- ingeniously designed handle and folding design makes the floodlight easy to transport

**Areas of use:** suitable for work lighting activities on construction sites, in workshops, car repair shops, garages.

|                   |              |
|-------------------|--------------|
| Lifetime (L80)    | 25 000 hours |
| CRI               | > 80         |
| Body material     | aluminium    |
| Diffuser material | plastic (PC) |
| IP rating         | IP44         |
| IK                | IK10         |
| Cable length      | 1.5 m        |

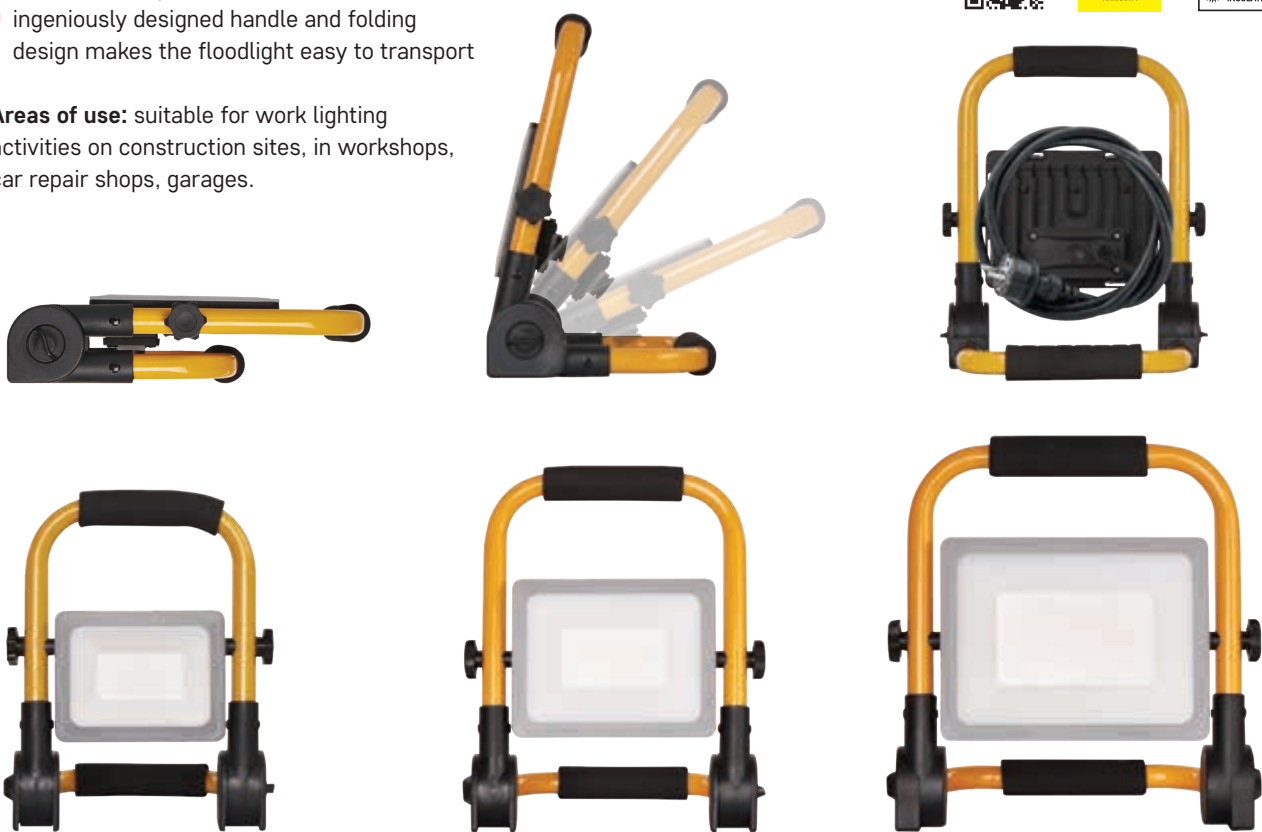

**ZS3322**

1/-/-/6

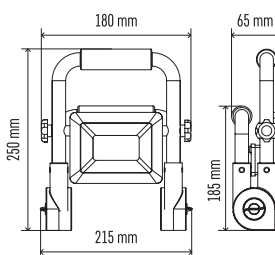

**ZS3332**

1/-/-/4

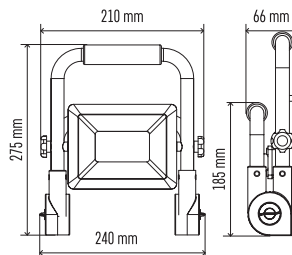

**ZS3342**

1/-/-/4

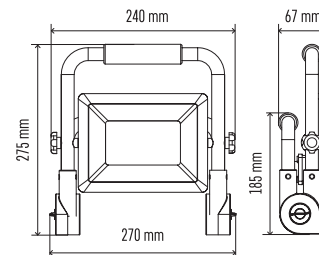

| Type   | EAN           | Power | Luminous Flux | CCT     | PF    | W × H × D          |
|--------|---------------|-------|---------------|---------|-------|--------------------|
| ZS3322 | 8592920104835 | 21 W  | 1 900 lm      | 4 000 K | > 0.9 | 215 × 250 × 185 mm |
| ZS3332 | 8592920104859 | 31 W  | 2 800 lm      | 4 000 K | > 0.9 | 240 × 275 × 185 mm |
| ZS3342 | 8592920104873 | 51 W  | 4 600 lm      | 4 000 K | > 0.9 | 270 × 275 × 185 mm |

## ACCO

The ACCO LED floodlights with battery offer maximum variability in workplace lighting where mains power is not available. Their robust design makes them suitable for working in harsh environments.

### Main benefits:

- no need for a nearby power socket
- IP54 rating ensures water resistance
- 120° lighting angle

**Areas of use:** lighting of workplaces on construction sites, at family houses, in garages, workshops, car repair shops, camping.



|                   |              |
|-------------------|--------------|
| Lifetime (L80)    | 25 000 hours |
| CRI               | > 80         |
| Body material     | aluminium    |
| Diffuser material | glass        |
| IP rating         | IP54         |
| IK                | IK08         |



**3 STEPS DIMMING**

**3 YEARS WARRANTY**



Rechargeable



**ZS2812**

☐ 1/-/-/5

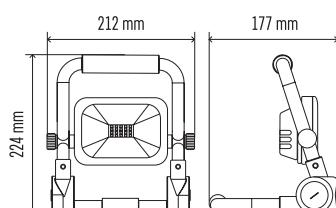

**ZS2822**

☐ 1/-/-/4

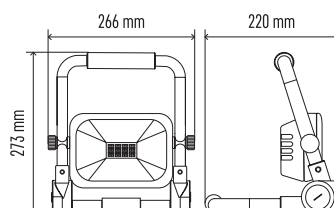

**ZS2832**

☐ 1/-/-/2

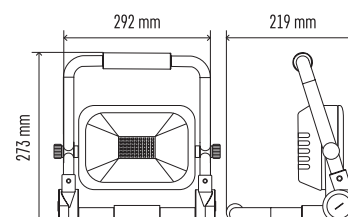

| Type   | EAN           | Power | Luminous Flux | CCT     | Flicker-Free | Dimmable | Accumulator       | Lighting Time on ACC | W × H × D          |
|--------|---------------|-------|---------------|---------|--------------|----------|-------------------|----------------------|--------------------|
| ZS2812 | 8592920108123 | 10 W  | 1 000 lm      | 6 500 K | yes          | yes      | Li-Ion 4 400 mAh  | 3 – 10 hours         | 212 × 224 × 177 mm |
| ZS2822 | 8592920108147 | 20 W  | 2 000 lm      | 6 500 K | yes          | yes      | Li-Ion 6 600 mAh  | 3 – 10 hours         | 266 × 273 × 220 mm |
| ZS2832 | 8592920108161 | 30 W  | 3 000 lm      | 6 500 K | yes          | yes      | Li-Ion 10 000 mAh | 3 – 10 hours         | 292 × 273 × 219 mm |

# Room Luminaires

## LED LINEAR

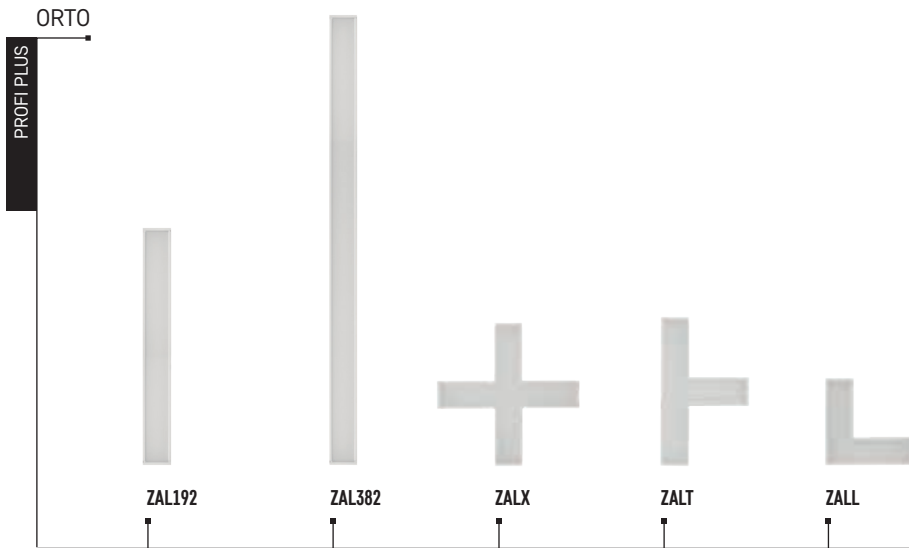

**ZALAP**  
Accessories for suspension mounting of linear luminaires.



**ZALAR**  
Accessories for recessed mounting of linear luminaires.



**ZALAS**  
Accessories for connecting the power supply of linear luminaires.

..... see page 38–39

## LARGE LED PANELS

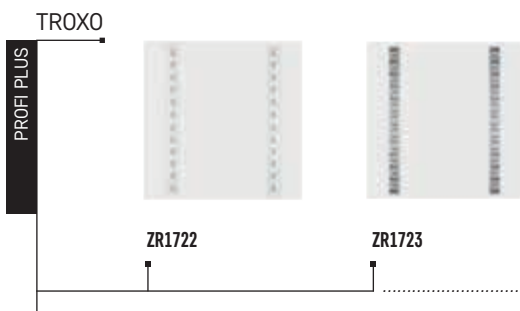

..... see page 40–41



..... see page 42–43



..... see page 44–45

## PIXXO

PROFI PLUS



ZR1532



..... see page 46

## REXXO

PROFI



ZB2214



ZB2224



ZR7612M

..... see page 47

## MAXXO

PROFI



ZR5410



ZR5412



ZR5421



ZR5422



ZR9041

..... see page 48



ZR8412

..... see page 49

## DAXXO

ESSENTIAL



ZB2414



..... see page 50

# ACCESSORIES FOR LED PANELS

## ACCESSORIES FOR LED PANELS



**4 SPRINGS**  
for 600 × 600 mm panel  
(300 mm)

**ZR9001**



**6 SPRINGS**  
for 1 200 × 300 mm panel

**ZR9002**



**4 HOOKS**  
for 600 × 600 mm panel  
(300 mm)

**ZR9010**



**6 HOOKS**  
for 1 200 × 300 mm panel

**ZR9011**



**4 CORDS FOR PENDANT  
INSTALLATION**  
**LENGTH 5–145 cm**  
for 600 × 600 mm panel (300 mm)

**ZR9020**

.....see page 51



**6 CORDS FOR PENDANT  
INSTALLATION LENGTH 5–145 cm**  
for 1 200 × 300 mm panel

**ZR9021**



**FRAME**  
for 600 × 600 mm panel  
screwless

**ZR9034**



**FRAME**  
for panel 300 × 1 200 mm  
panel screwless

**ZR9035**

.....see page 51



**FRAME**  
for 600 × 600 mm panel  
screwless

**ZR9036**



**REMOTE CONTROLER**  
for ZR5410

**ZR9041**

.....see page 51



# ORTO

Modern linear ORTO luminaires are made of high quality aluminium profile. Multiple luminaires can be connected to each other in different shapes using connectors. The connectors ZALX, ZALT and ZALL light up only when connected to linear luminaires ZAL192 or ZAL382.

## Main benefits:

- ready for continuous installation in linear wiring
- possibility of mounted, built-in or hanging installation

**Areas of use:** office lighting, sales areas, interior spaces

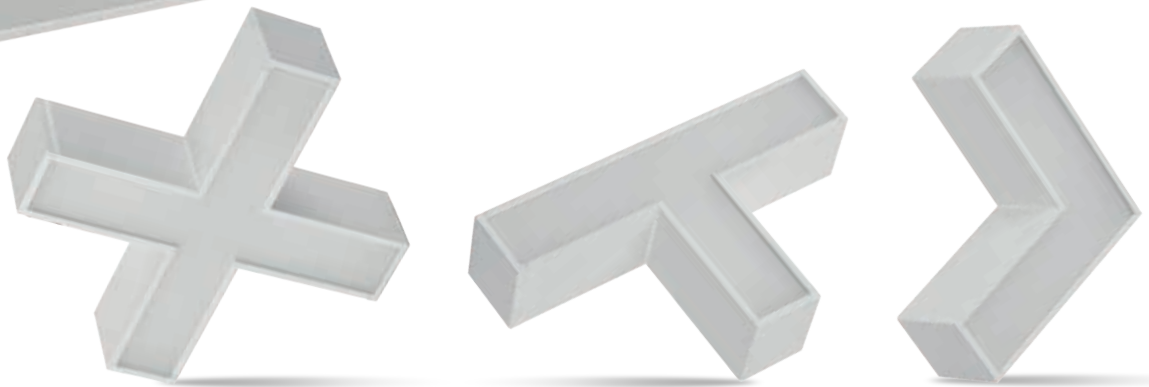

## ZAL192

1/-/-/6

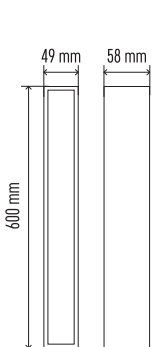

## ZAL382

1/-/-/6

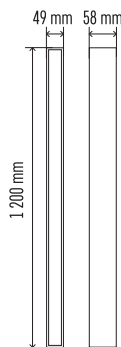

## ZALX

1/-/-/6

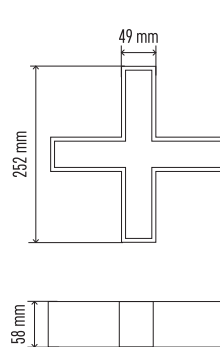

## ZALT

1/-/-/8

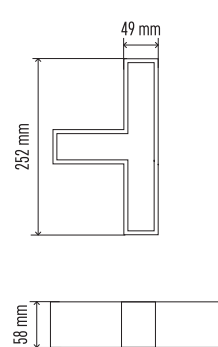

## ZALL

1/-/-/12

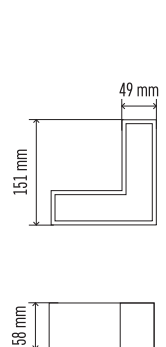

| Type   | EAN           | Power | Luminous Flux | CCT     | PF    | Diffuser Type | Beam Angle | Luminous Efficacy | UGR | W × H × D          |
|--------|---------------|-------|---------------|---------|-------|---------------|------------|-------------------|-----|--------------------|
| ZAL192 | 8592920114353 | 19 W  | 2 000 lm      | 4 000 K | > 0.9 | milky         | 110°       | 105 lm/W          | 22  | 600 × 58 × 49 mm   |
| ZAL382 | 8592920114377 | 38 W  | 4 200 lm      | 4 000 K | > 0.9 | milky         | 110°       | 110 lm/W          | 22  | 1 200 × 58 × 49 mm |
| ZALX   | 8592920114391 | 15 W  | 1 500 lm      | 4 000 K | > 0.9 | milky         | 110°       | 100 lm/W          | 22  | 252 × 252 × 58 mm  |
| ZALT   | 8592920114414 | 12 W  | 1 200 lm      | 4 000 K | > 0.9 | milky         | 110°       | 100 lm/W          | 22  | 252 × 151 × 58 mm  |
| ZALL   | 8592920114438 | 8 W   | 800 lm        | 4 000 K | > 0.9 | milky         | 110°       | 100 lm/W          | 22  | 151 × 151 × 58 mm  |





|                   |              |
|-------------------|--------------|
| Lifetime (L80)    | 50 000 hours |
| CRI               | > 80         |
| Body material     | aluminium    |
| Diffuser material | plastic (PS) |
| IP rating         | IP20         |



Photometric data available at [www.emos.eu/LDT](http://www.emos.eu/LDT)

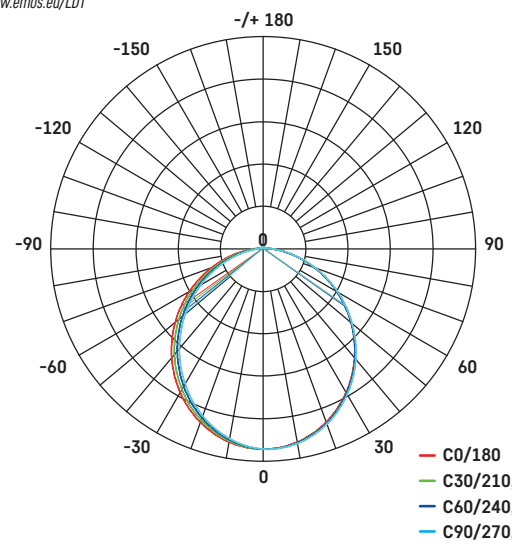

### ZALAP

1/-/-100



### ZALAR

1/-/-36



### ZALAS

1/-/-24

| Type  | EAN           | Item Name   |
|-------|---------------|---|
| ZALAP | 8592920114452 | Accessories for hanging mounting of linear luminaires.            |
| ZALAR | 8592920114476 | Accessories for recessed mounting of linear luminaires.           |
| ZALAS | 8592920115473 | Accessories for connecting the power supply of linear luminaires. |

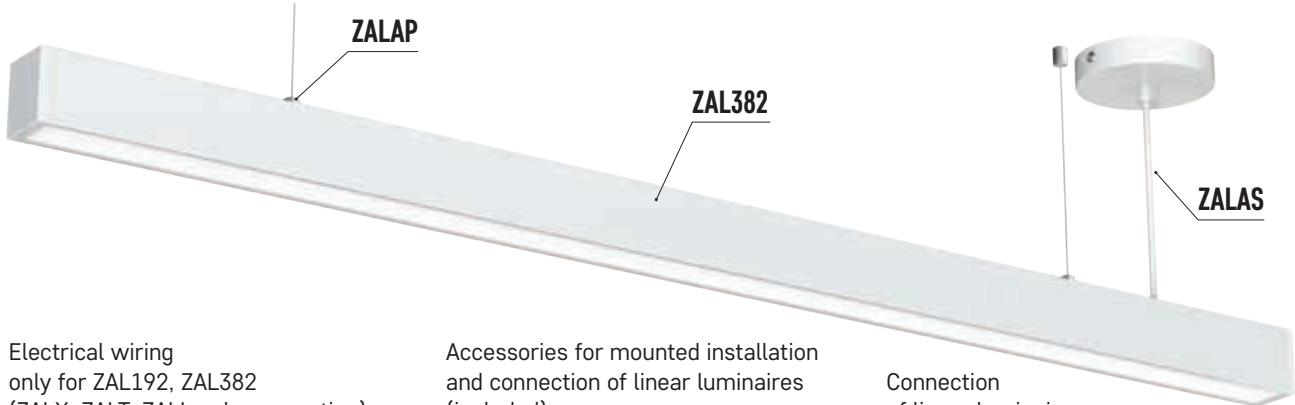

Electrical wiring only for ZAL192, ZAL382 (ZALX, ZALT, ZALL only connection)



Accessories for mounted installation and connection of linear luminaires (included)

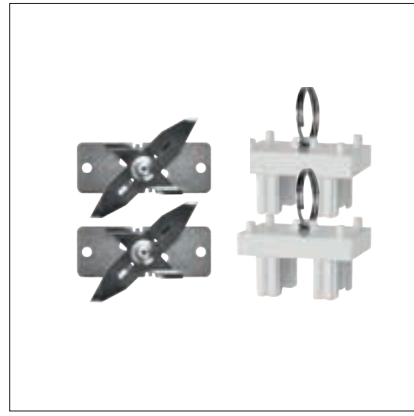

Connection of linear luminaires

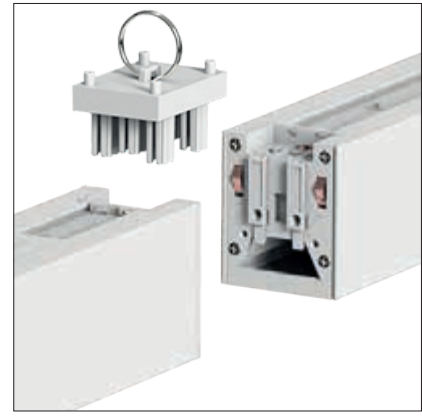

# TROXO

TROXO LED panels combine an attractive square design, high luminous efficiency and energy savings. They excel in indoor areas where pleasant diffused light with a very low glare index is particularly needed.

## Main benefits:

- thanks to the LED technology used and the shape of the diffuser, it illuminates the room with adequate intensity at an angle of 85°
- so the beam of the luminaire does not dazzle the surroundings with an unnecessarily wide beam angle

**Areas of use:** lighting of hall, offices, classrooms, conference halls or department stores.

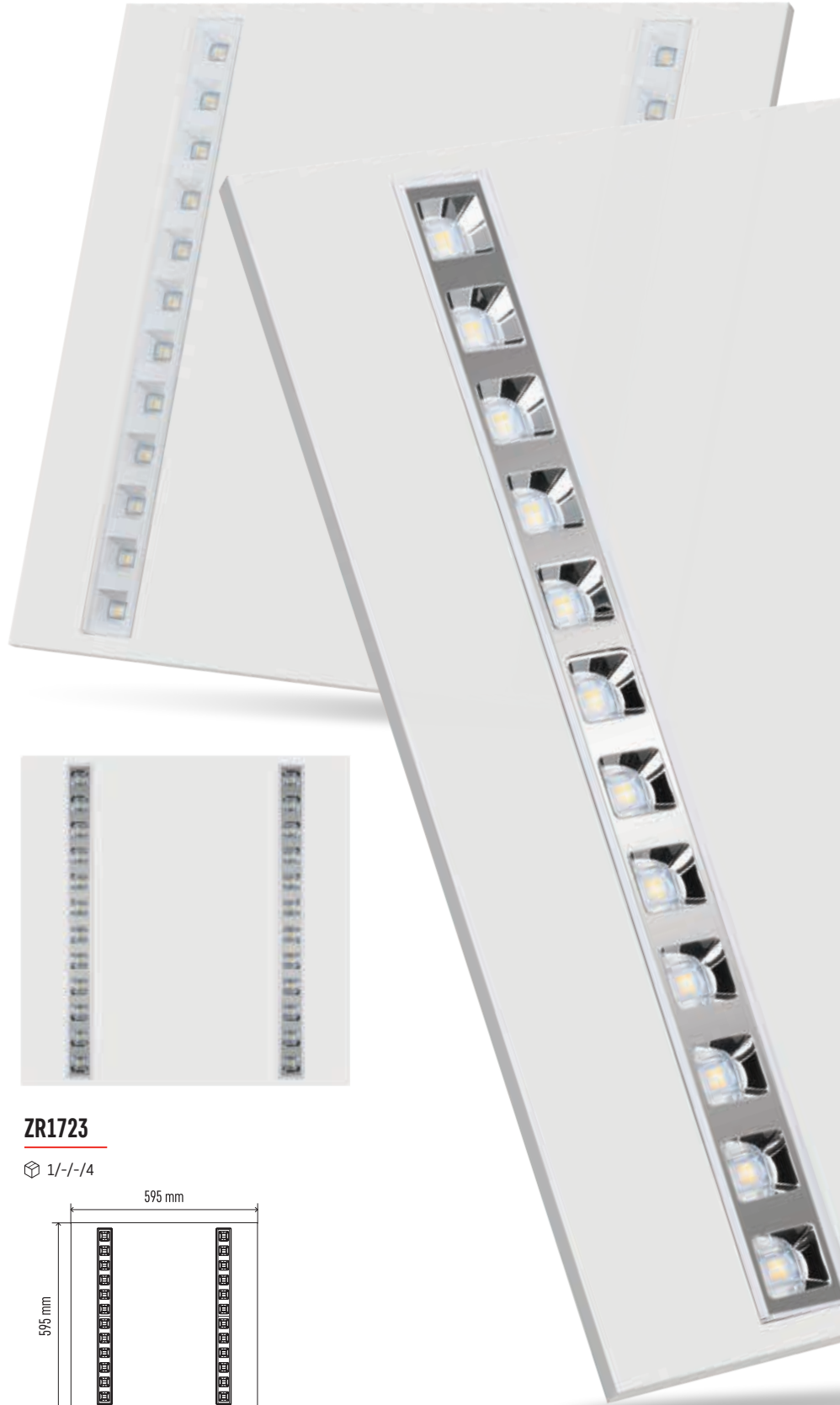

## ZR1722

1/-/-/4

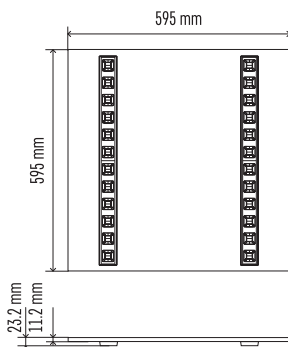

## ZR1723

1/-/-/4

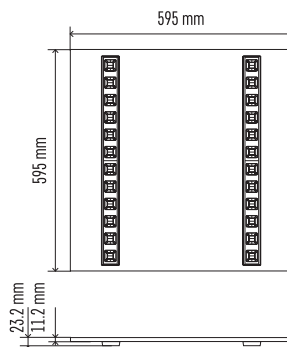

| Type     | EAN           | Power | Luminous Flux | Replacement for | CCT     | PF    | Luminous Efficacy | UGR< | Flicker-Free | W × H × D           |
|----------|---------------|-------|---------------|-----------------|---------|-------|-------------------|------|--------------|---------------------|
| ZR1722   | 8592920097953 | 27 W  | 3 150 lm      | 4 × 18 W CFL    | 4 000 K | > 0.9 | 117 lm/W          | 16   | yes          | 595 × 595 × 23.2 mm |
| ZR1723   | 8592920097977 | 36 W  | 4 240 lm      | 4 × 18 W CFL    | 4 000 K | > 0.9 | 118 lm/W          | 16   | yes          | 595 × 595 × 23.2 mm |
| ZR1722DA | 8592920113776 | 27 W  | 3 150 lm      | 4 × 18 W CFL    | 4 000 K | > 0.9 | 117 lm/W          | 16   | yes          | 595 × 595 × 23.2 mm |
| ZR1723DA | 8592920113783 | 36 W  | 4 240 lm      | 4 × 18 W CFL    | 4 000 K | > 0.9 | 118 lm/W          | 16   | yes          | 595 × 595 × 23.2 mm |

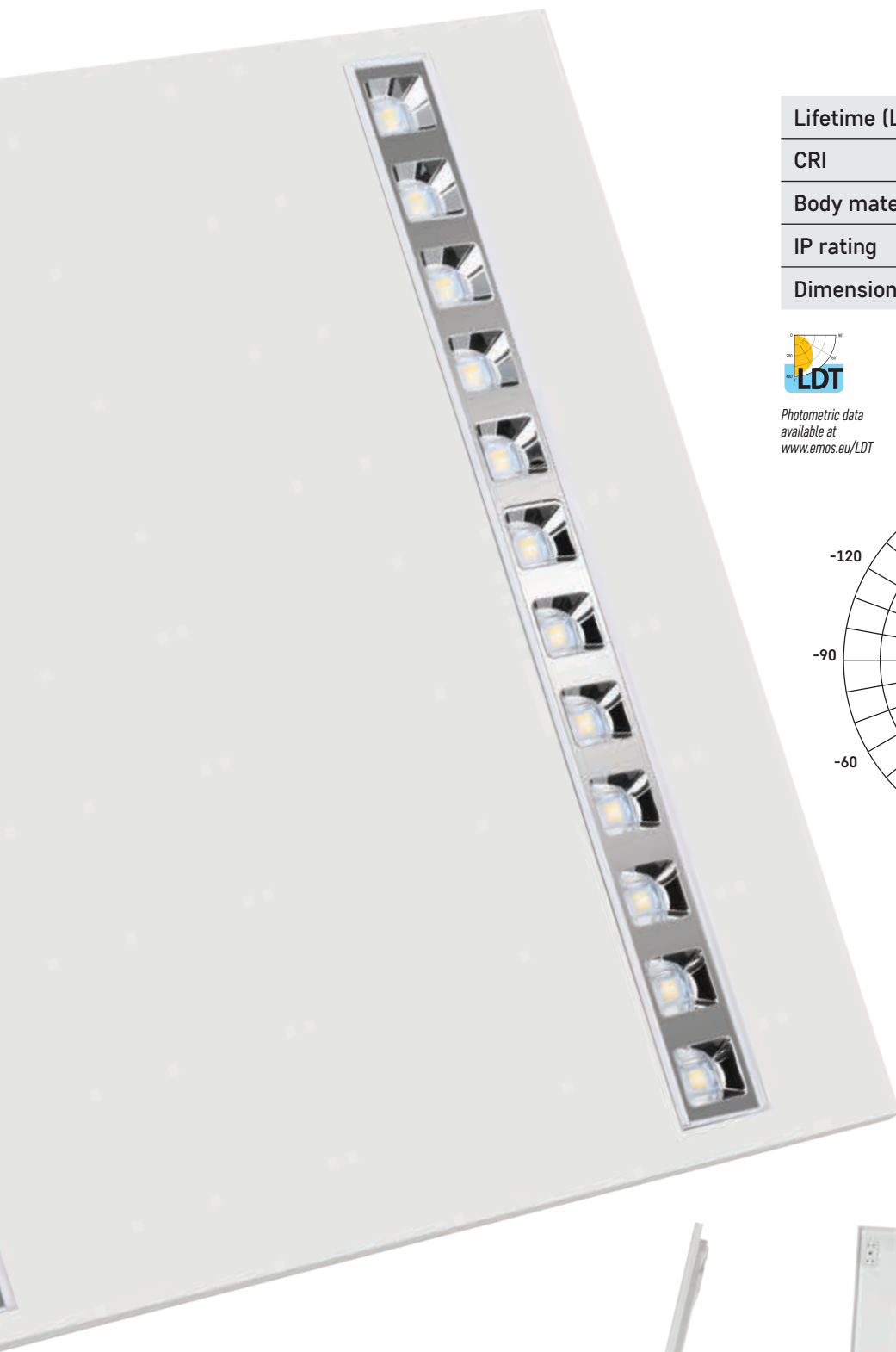

|                |              |
|----------------|--------------|
| Lifetime (L80) | 40 000 hours |
| CRI            | > 80         |
| Body material  | sheet steel  |
| IP rating      | IP20         |
| Dimensions     | 595 × 595 mm |



Photometric data  
available at  
[www.emos.eu/LDT](http://www.emos.eu/LDT)

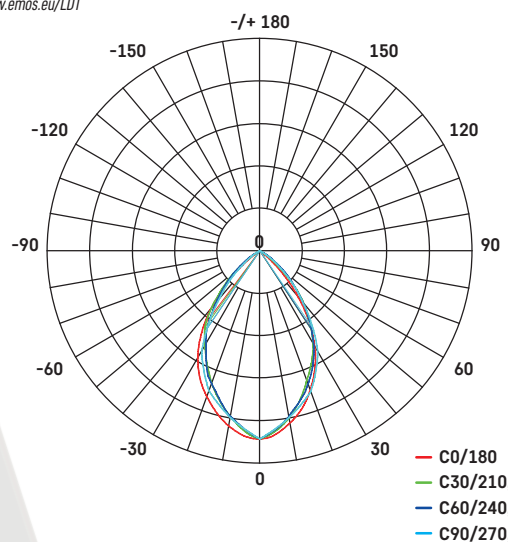

### Set with additional dimmable driver

| Type     | Panel    | Dimmable power supply |
|----------|----------|-----------------------|
| ZR1722DA | = ZR1722 | + ZZ409BD             |
| ZR1723DA | = ZR1723 | + ZZ409BD             |

See page 134

# PROXO

The square or rectangular luminaires of the PROXO series are an effective option for indoor lighting. High colour rendering index models are also available for spaces where accurate colour rendering is required.

### Main benefits:

- high efficiency and energy saving
- glare factor UGR < 19
- light-guiding plate (LGP) resistance to yellowing due to UV radiation

**Areas of use:** offices, classrooms and indoor areas.

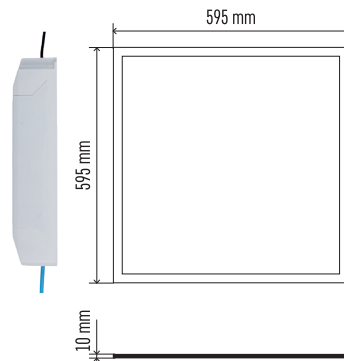

**ZR1433**

1/-/-/5

**ZR1422**

1/-/-/4

**ZR1412**

1/-/-/4

|                   |              |
|-------------------|--------------|
| Lifetime (L80)    | 40 000 hours |
| CRI               | > 80         |
| Body material     | aluminium    |
| Diffuser material | plastic (PC) |
| LGP material      | PMMA         |
| IP rating         | IP20         |
| Dimensions        | 595 × 595 mm |



Photometric data available at [www.emos.eu/LDT](http://www.emos.eu/LDT)

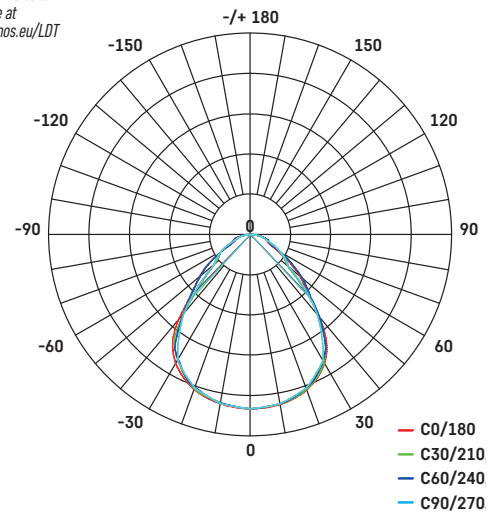

### Set with additional dimmable driver

| Type     | Panel    | Dimmable power supply |
|----------|----------|-----------------------|
| ZR1433DA | = ZR1433 | + ZZ409BD             |
| ZR1422DA | = ZR1422 | + ZZ409BD             |
| ZR1412DA | = ZR1412 | + ZZ409BD             |

See page 134

### Set with additional emergency driver

| Type    | Panel    | Emergency power supply |
|---------|----------|------------------------|
| ZR1433E | = ZR1433 | + ZR9310               |
| ZR1422E | = ZR1422 | + ZR9310               |
| ZR1412E | = ZR1412 | + ZR9310               |

See page 127

| Type     | EAN           | Power | Luminous Flux | Equivalent Power | CCT     | PF    | Diffuser Type  | Luminous Efficacy | UGR< | Flicker-Free | W × H × D         |
|----------|---------------|-------|---------------|------------------|---------|-------|----------------|-------------------|------|--------------|-------------------|
| ZR1433   | 8592920083291 | 40 W  | 3 700 lm      | 4 × 18 W CFL     | 4 000 K | > 0.9 | microprismatic | 92.5 lm/W         | 19   | yes          | 595 × 595 × 10 mm |
| ZR1422   | 8592920034071 | 40 W  | 4 000 lm      | 4 × 18 W CFL     | 4 000 K | > 0.9 | microprismatic | 100 lm/W          | 19   | yes          | 595 × 595 × 10 mm |
| ZR1412   | 8592920034057 | 40 W  | 4 240 lm      | 4 × 18 W CFL     | 4 000 K | > 0.9 | milky          | 106 lm/W          | 22   | yes          | 595 × 595 × 10 mm |
| ZR1433DA | 8592920113424 | 40 W  | 3 700 lm      | 4 × 18 W CFL     | 4 000 K | > 0.9 | microprismatic | 92.5 lm/W         | 19   | yes          | 595 × 595 × 10 mm |
| ZR1422DA | 8592920113431 | 40 W  | 4 000 lm      | 4 × 18 W CFL     | 4 000 K | > 0.9 | microprismatic | 100 lm/W          | 19   | yes          | 595 × 595 × 10 mm |
| ZR1412DA | 8592920113448 | 40 W  | 4 240 lm      | 4 × 18 W CFL     | 4 000 K | > 0.9 | milky          | 106 lm/W          | 22   | yes          | 595 × 595 × 10 mm |
| ZR1433E  | 8592920085226 | 40 W  | 3 700 lm      | 4 × 18 W CFL     | 4 000 K | > 0.9 | microprismatic | 92.5 lm/W         | 19   | yes          | 595 × 595 × 10 mm |
| ZR1422E  | 8592920085257 | 40 W  | 4 000 lm      | 4 × 18 W CFL     | 4 000 K | > 0.9 | microprismatic | 100 lm/W          | 19   | yes          | 595 × 595 × 10 mm |
| ZR1412E  | 8592920085264 | 40 W  | 4 240 lm      | 4 × 18 W CFL     | 4 000 K | > 0.9 | milky          | 106 lm/W          | 22   | yes          | 595 × 595 × 10 mm |

|                   |                                |
|-------------------|--------------------------------|
| Lifetime (L80)    | 40 000 hours                   |
| CRI               | > 80                           |
| Body material     | aluminium                      |
| Diffuser material | plastic (PC)                   |
| LGP material      | PMMA                           |
| IP rating         | IP20                           |
| Dimensions        | 595 × 295 mm<br>1 195 × 295 mm |



Photometric data available at [www.emos.eu/LDT](http://www.emos.eu/LDT)

**5**  
YEARS  
WARRANTY

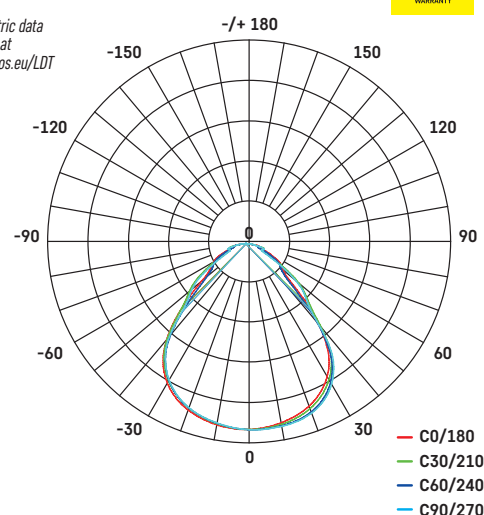

**ZR3422**

**ZR3412**

1/-/-/4

1/-/-/4

1 195 mm

295 mm

11,4 mm

**ZR2212**

1/-/-/8

595 mm

295 mm

10,4 mm

### Set with additional dimmable driver

| Type            | Panel           | Dimmable power supply |
|-----------------|-----------------|-----------------------|
| <b>ZR3422DA</b> | = <b>ZR3422</b> | + <b>ZZ409BD</b>      |
| <b>ZR3412DA</b> | = <b>ZR3412</b> | + <b>ZZ409BD</b>      |
| <b>ZR2212DA</b> | = <b>ZR2212</b> | + <b>ZZ409BD</b>      |

See page 134

### Set with additional emergency driver

| Type           | Panel           | Emergency power supply |
|----------------|-----------------|------------------------|
| <b>ZR3422E</b> | = <b>ZR3422</b> | + <b>ZR9310</b>        |
| <b>ZR3412E</b> | = <b>ZR3412</b> | + <b>ZR9310</b>        |
| <b>ZR2212E</b> | = <b>ZR2212</b> | + <b>ZR9310</b>        |

See page 127

| Type            | EAN           | Power | Luminous Flux | Equivalent Power | CCT     | PF    | Diffuser Type  | Luminous Efficacy | UGR< | Flicker-Free | W × H × D             |
|-----------------|---------------|-------|---------------|------------------|---------|-------|----------------|-------------------|------|--------------|-----------------------|
| <b>ZR3422</b>   | 8592920069875 | 40 W  | 4 000 lm      | 2 × 36 W CFL     | 4 000 K | > 0.9 | microprismatic | 100 lm/W          | 19   | yes          | 1 195 × 295 × 11.4 mm |
| <b>ZR3412</b>   | 8592920034118 | 40 W  | 4 240 lm      | 2 × 36 W CFL     | 4 000 K | > 0.9 | microprismatic | 106 lm/W          | 22   | yes          | 1 195 × 295 × 11.4 mm |
| <b>ZR2212</b>   | 8592920034095 | 19 W  | 1 800 lm      | 2 × 18 W CFL     | 4 000 K | > 0.9 | milky          | 95 lm/W           | 22   | yes          | 595 × 295 × 10.4 mm   |
| <b>ZR3422DA</b> | 8592920113455 | 40 W  | 4 000 lm      | 2 × 36 W CFL     | 4 000 K | > 0.9 | microprismatic | 100 lm/W          | 19   | yes          | 1 195 × 295 × 11.4 mm |
| <b>ZR3412DA</b> | 8592920113462 | 40 W  | 4 240 lm      | 2 × 36 W CFL     | 4 000 K | > 0.9 | microprismatic | 106 lm/W          | 22   | yes          | 1 195 × 295 × 11.4 mm |
| <b>ZR2212DA</b> | 8592920113790 | 19 W  | 1 800 lm      | 2 × 18 W CFL     | 4 000 K | > 0.9 | milky          | 95 lm/W           | 22   | yes          | 595 × 295 × 10.4 mm   |
| <b>ZR3422E</b>  | 8592920085325 | 40 W  | 4 000 lm      | 2 × 36 W CFL     | 4 000 K | > 0.9 | microprismatic | 100 lm/W          | 19   | yes          | 1 195 × 295 × 11.4 mm |
| <b>ZR3412E</b>  | 8592920085332 | 40 W  | 4 240 lm      | 2 × 36 W CFL     | 4 000 K | > 0.9 | milky          | 106 lm/W          | 22   | yes          | 1 195 × 295 × 11.4 mm |
| <b>ZR2212E</b>  | 8592920085349 | 19 W  | 1 800 lm      | 2 × 18 W CFL     | 4 000 K | > 0.9 | milky          | 95 lm/W           | 22   | yes          | 595 × 295 × 10.4 mm   |

# LEX XO

Modern energy-saving LEX XO luminaires use backlit technology. Compared to conventional panels, it offers more uniform light emission and higher luminous efficiency.

### Main benefits:

- high efficacy and even distribution of light
- outstanding performance and lighting quality – CRI > 80
- pleasantly diffused light

**Areas of use:** offices, classrooms and indoor areas.

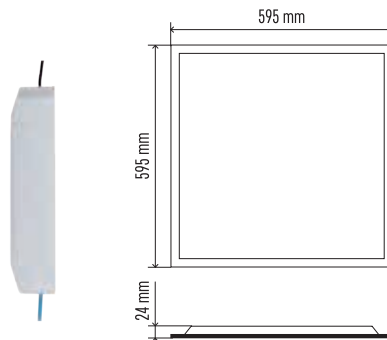

**ZB2114**

1/-/-/4

**ZB2124**

1/-/-/4

|                   |              |
|-------------------|--------------|
| Lifetime (L80)    | 50 000 hours |
| CRI               | > 80         |
| Body material     | sheet steel  |
| Diffuser material | plastic (PC) |
| IP rating         | IP20         |
| Dimensions        | 595 × 595 mm |



Photometric data  
available at  
[www.emos.eu/LDT](http://www.emos.eu/LDT)

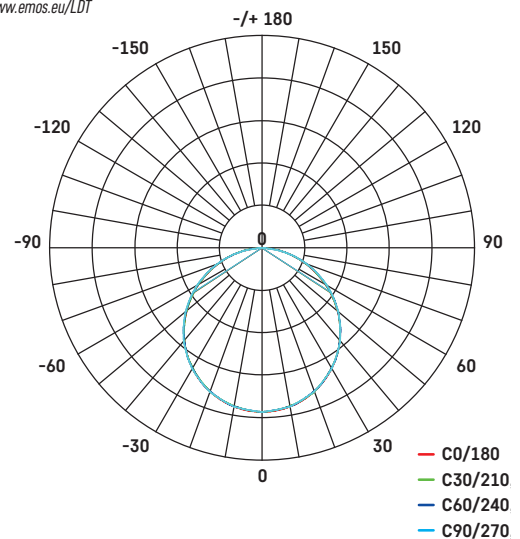

### Set with additional dimmable driver

| Type           | Panel           | Dimmable power supply |
|----------------|-----------------|-----------------------|
| <b>ZB2114D</b> | = <b>ZB2114</b> | + <b>ZZ409BD</b>      |
| <b>ZB2124D</b> | = <b>ZB2124</b> | + <b>ZZ409BD</b>      |

See page 134

### Set with additional emergency driver

| Type           | Panel           | Emergency power supply |
|----------------|-----------------|------------------------|
| <b>ZB2114E</b> | = <b>ZB2114</b> | + <b>ZR9310</b>        |
| <b>ZB2124E</b> | = <b>ZB2124</b> | + <b>ZR9310</b>        |

See page 127

| Type           | EAN           | Power | Luminous Flux | Equivalent Power | CCT     | PF    | Diffuser Type | Luminous Efficacy | UGR < | Flicker-Free | W × H × D         |
|----------------|---------------|-------|---------------|------------------|---------|-------|---------------|-------------------|-------|--------------|-------------------|
| <b>ZB2114</b>  | 8592920123317 | 30 W  | 4 200 lm      | 4 × 18 W CFL     | 4 000 K | > 0.9 | milky         | 140 lm/W          | 22    | yes          | 595 × 595 × 24 mm |
| <b>ZB2124</b>  | 8592920123317 | 30 W  | 4 200 lm      | 4 × 18 W CFL     | 4 000 K | > 0.9 | milky         | 140 lm/W          | 19    | yes          | 595 × 595 × 24 mm |
| <b>ZB2114D</b> | 8592920123324 | 30 W  | 4 200 lm      | 4 × 18 W CFL     | 4 000 K | > 0.9 | milky         | 140 lm/W          | 22    | yes          | 595 × 595 × 24 mm |
| <b>ZB2114E</b> | 8592920123331 | 30 W  | 4 200 lm      | 4 × 18 W CFL     | 4 000 K | > 0.9 | milky         | 140 lm/W          | 22    | yes          | 595 × 595 × 24 mm |
| <b>ZB2124D</b> | 8592920123348 | 30 W  | 4 000 lm      | 4 × 18 W CFL     | 4 000 K | > 0.9 | milky         | 133 lm/W          | 19    | yes          | 595 × 595 × 24 mm |
| <b>ZB2124E</b> | 8592920123355 | 30 W  | 4 000 lm      | 4 × 18 W CFL     | 4 000 K | > 0.9 | milky         | 133 lm/W          | 19    | yes          | 595 × 595 × 24 mm |

|                   |              |
|-------------------|--------------|
| Lifetime (L80)    | 45 000 hours |
| CRI               | > 80         |
| Body material     | sheet steel  |
| Diffuser material | plastic (PS) |
| IP rating         | IP20/IP54    |
| Dimensions        | 595 × 595 mm |



Photometric data available at [www.emos.eu/LDT](http://www.emos.eu/LDT)

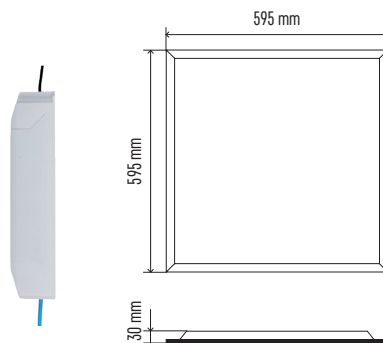
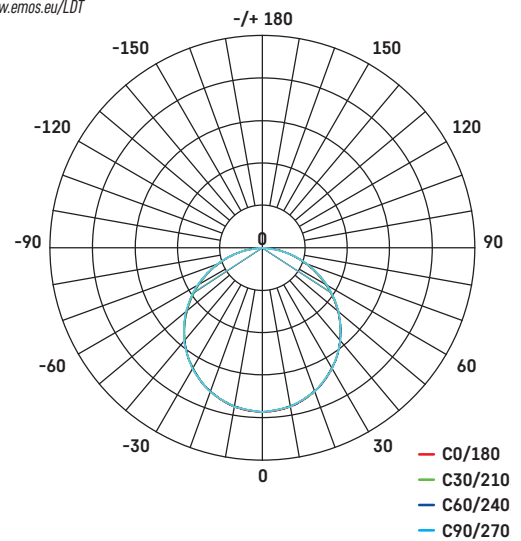

**ZR1622**

1/-/-/4

**ZR1612**

1/-/-/4

**ZR1642**

1/-/-/4

### Set with additional dimmable driver

| Type            | Panel           | Dimmable power supply |
|-----------------|-----------------|-----------------------|
| <b>ZR1622DA</b> | = <b>ZR1622</b> | + <b>ZZ409BD</b>      |
| <b>ZR1612DA</b> | = <b>ZR1612</b> | + <b>ZZ409BD</b>      |

See page 134

### Set with additional emergency driver

| Type           | Panel           | Emergency power supply |
|----------------|-----------------|------------------------|
| <b>ZR1622E</b> | = <b>ZR1622</b> | + <b>ZR9310</b>        |
| <b>ZR1612E</b> | = <b>ZR1612</b> | + <b>ZR9310</b>        |

See page 127

| Type            | EAN           | Power | Luminous Flux | Equivalent Power | CCT     | PF    | Diffuser Type  | Luminous Efficacy | UGR < | Flicker-Free | W × H × D         |
|-----------------|---------------|-------|---------------|------------------|---------|-------|----------------|-------------------|-------|--------------|-------------------|
| <b>ZR1622</b>   | 8592920085523 | 34 W  | 4 000 lm      | 4 × 18 W CFL     | 4 000 K | > 0.9 | microprismatic | 118 lm/W          | 19    | yes          | 595 × 595 × 30 mm |
| <b>ZR1612</b>   | 8592920085530 | 34 W  | 4 200 lm      | 4 × 18 W CFL     | 4 000 K | > 0.9 | milky          | 123 lm/W          | 22    | yes          | 595 × 595 × 30 mm |
| <b>ZR1642</b>   | 8592920117170 | 34 W  | 4 200 lm      | 4 × 18 W CFL     | 4 000 K | > 0.9 | milky          | 123 lm/W          | 22    | yes          | 595 × 595 × 30 mm |
| <b>ZR1622DA</b> | 8592920113479 | 34 W  | 4 000 lm      | 4 × 18 W CFL     | 4 000 K | > 0.9 | microprismatic | 118 lm/W          | 19    | yes          | 595 × 595 × 30 mm |
| <b>ZR1612DA</b> | 8592920113486 | 34 W  | 4 200 lm      | 4 × 18 W CFL     | 4 000 K | > 0.9 | milky          | 123 lm/W          | 22    | yes          | 595 × 595 × 30 mm |
| <b>ZR1622E</b>  | 8592920085295 | 34 W  | 4 000 lm      | 4 × 18 W CFL     | 4 000 K | > 0.9 | microprismatic | 118 lm/W          | 19    | yes          | 595 × 595 × 30 mm |
| <b>ZR1612E</b>  | 8592920085301 | 34 W  | 4 200 lm      | 4 × 18 W CFL     | 4 000 K | > 0.9 | milky          | 123 lm/W          | 22    | yes          | 595 × 595 × 30 mm |

# PIXXO

The economical PIXXO square-shaped luminaire is designed for professional indoor lighting where increased water resistance is required.

#### Main benefits:

- IP65 protection guarantees water resistance
- resistance of the light-conducting plate (LGP) against yellowing due to UV radiation

**Areas of use:** offices, classrooms and indoor areas.

|                   |              |
|-------------------|--------------|
| Lifetime (L80)    | 40 000 hours |
| CRI               | > 80         |
| Body material     | aluminium    |
| Diffuser material | plastic (PC) |
| IP rating         | IP65         |
| Dimensions        | 595 × 595 mm |



Photometric data available at [www.emos.eu/LDT](http://www.emos.eu/LDT)

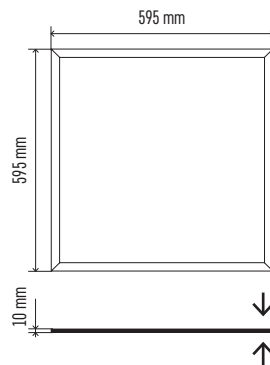
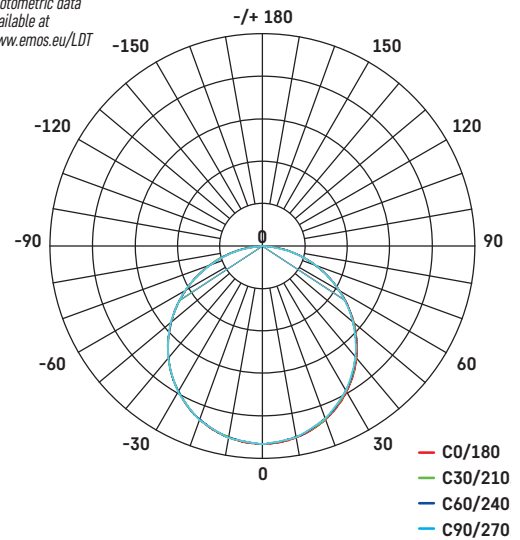

## ZR1532

1/-/-/4

| Type   | EAN           | Power | Luminous Flux | Equivalent Power | CCT     | PF    | Diffuser Type | Luminous Efficacy | UGR < | Flicker-Free | W × H × D         |
|--------|---------------|-------|---------------|------------------|---------|-------|---------------|-------------------|-------|--------------|-------------------|
| ZR1532 | 8592920067826 | 48 W  | 4 800 lm      | 4 × 18 W CFL     | 4 000 K | > 0.9 | milky         | 100 lm/W          | 22    | yes          | 595 × 595 × 10 mm |



# REXXO

Modern energy-saving REXXO luminaires use backlight technology. Compared to conventional panels, it offers more uniform light emission and higher luminous efficiency.

## Main benefits:

- high efficacy and even distribution of light
- outstanding performance and lighting quality – CRI ≥ 80
- pleasantly diffused light

**Areas of use:** offices, classrooms and indoor areas.

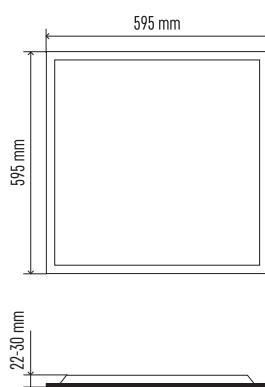

**ZB2214**

1/-/-/6

**ZB2224**

1/-/-/6

**ZR7612M**

1/-/-/5

**3**  
YEARS  
WARRANTY

|                   |              |
|-------------------|--------------|
| Lifetime (L80)    | 50 000 hours |
| CRI               | > 80         |
| Body material     | sheet steel  |
| Diffuser material | plastic (PC) |
| IP rating         | IP20         |



Photometric data  
available at  
[www.emos.eu/LDT](http://www.emos.eu/LDT)

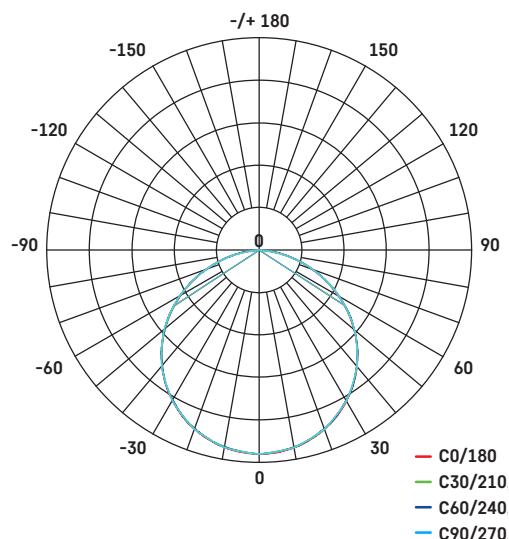

## Set with additional dimmable driver

| Type           | Panel           | Dimmable power supply |
|----------------|-----------------|-----------------------|
| <b>ZB2214D</b> | = <b>ZB2214</b> | + <b>ZZ409BD</b>      |
| <b>ZB2224D</b> | = <b>ZB2224</b> | + <b>ZZ409BD</b>      |

See page 134

## Set with additional emergency driver

| Type           | Panel           | Dimmable power supply |
|----------------|-----------------|-----------------------|
| <b>ZB2214E</b> | = <b>ZB2214</b> | + <b>ZR9310</b>       |
| <b>ZB2224E</b> | = <b>ZB2224</b> | + <b>ZR9310</b>       |

See page 127

| Type           | EAN           | Power | Luminous Flux | Equivalent Power | CCT     | PF    | Diffuser Type | Luminous Efficacy | UGR < | Flicker-Free | W × H × D         |
|----------------|---------------|-------|---------------|------------------|---------|-------|---------------|-------------------|-------|--------------|-------------------|
| <b>ZB2214</b>  | 8592920121368 | 36 W  | 4 000 lm      | 4 × 18 W CFL     | 4 000 K | > 0.9 | milky         | 110 lm/W          | 22    | yes          | 595 × 595 × 24 mm |
| <b>ZB2224</b>  | 8592920121382 | 36 W  | 4 000 lm      | 4 × 18 W CFL     | 4 000 K | > 0.9 | milky         | 110 lm/W          | 19    | yes          | 595 × 595 × 24 mm |
| <b>ZR7612M</b> | 8592920092262 | 40 W  | 4 000 lm      | 4 × 18 W CFL     | 4 000 K | > 0.9 | milky         | 100 lm/W          | 22    | yes          | 595 × 595 × 30 mm |
| <b>ZB2214D</b> | 8592920123263 | 36 W  | 4 000 lm      | 4 × 18 W CFL     | 4 000 K | > 0.9 | milky         | 110 lm/W          | 22    | yes          | 595 × 595 × 24 mm |
| <b>ZB2214E</b> | 8592920123270 | 36 W  | 4 000 lm      | 4 × 18 W CFL     | 4 000 K | > 0.9 | milky         | 110 lm/W          | 22    | yes          | 595 × 595 × 24 mm |
| <b>ZB2224D</b> | 8592920123287 | 36 W  | 4 000 lm      | 4 × 18 W CFL     | 4 000 K | > 0.9 | milky         | 110 lm/W          | 19    | yes          | 595 × 595 × 24 mm |
| <b>ZB2224E</b> | 8592920123294 | 36 W  | 4 000 lm      | 4 × 18 W CFL     | 4 000 K | > 0.9 | milky         | 110 lm/W          | 19    | yes          | 595 × 595 × 24 mm |

# MAXXO

The square and rectangular luminaires of the MAXXO series represent an economical option for lighting especially office spaces.

### Main benefits:

- high efficiency and energy saving
- pleasantly diffused light
- option to purchase a remote control for the ZR5410

**Areas of use:** offices, classrooms and indoor areas.



### ZR5410

☐ 1/-/-/4

### ZR5412

☐ 1/-/-/5

### ZR5421

☐ 1/-/-/5

### ZR5422

☐ 1/-/-/5

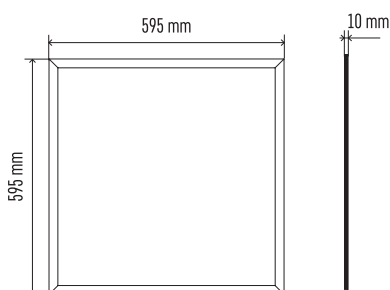

### ZR9041

☐ 1/-/-/100

EAN: 8592920097830

### Set with additional dimmable driver

| Type     | Panel    | Dimmable power supply |
|----------|----------|-----------------------|
| ZR5422DA | = ZR5422 | + ZZ409BD             |
| ZR5421DA | = ZR5421 | + ZZ409BD             |
| ZR5412DA | = ZR5412 | + ZZ409BD             |

See page 134

### Set with additional emergency driver

| Type    | Panel    | Emergency power supply |
|---------|----------|------------------------|
| ZR5422E | = ZR5422 | + ZR9310               |
| ZR5421E | = ZR5421 | + ZR9310               |
| ZR5412E | = ZR5412 | + ZR9310               |

See page 127

| Type     | EAN           | Power | Luminous Flux | Equivalent Power | CCT           | PF    | Diffuser Type  | Luminous Efficacy | UGR < | Flicker-Free | W × H × D         |
|----------|---------------|-------|---------------|------------------|---------------|-------|----------------|-------------------|-------|--------------|-------------------|
| ZR5410   | 8592920097427 | 36 W  | 3 600 lm      | 4 × 18 W CFL     | 2 700–6 000 K | > 0.9 | microprismatic | 100 lm/W          | 19    | yes          | 595 × 595 × 10 mm |
| ZR5412   | 8592920040355 | 40 W  | 4 400 lm      | 4 × 18 W CFL     | 4 000 K       | > 0.9 | milky          | 110 lm/W          | 22    | yes          | 595 × 595 × 10 mm |
| ZR5412.2 | 8592920118948 | 40 W  | 4 400 lm      | 4 × 18 W CFL     | 4 000 K       | > 0.9 | milky          | 110 lm/W          | 22    | yes          | 595 × 595 × 10 mm |
| ZR5421   | 8592920075449 | 40 W  | 4 090 lm      | 4 × 18 W CFL     | 3 000 K       | > 0.9 | microprismatic | 102 lm/W          | 19    | yes          | 595 × 595 × 10 mm |
| ZR5422   | 8592920040379 | 40 W  | 4 400 lm      | 4 × 18 W CFL     | 4 000 K       | > 0.9 | microprismatic | 110 lm/W          | 19    | yes          | 595 × 595 × 10 mm |
| ZR5412DA | 8592920113820 | 40 W  | 4 400 lm      | 4 × 18 W CFL     | 4 000 K       | > 0.9 | milky          | 110 lm/W          | 22    | yes          | 595 × 595 × 10 mm |
| ZR5421DA | 8592920113813 | 40 W  | 4 090 lm      | 4 × 18 W CFL     | 3 000 K       | > 0.9 | microprismatic | 102 lm/W          | 19    | yes          | 595 × 595 × 10 mm |
| ZR5422DA | 8592920113806 | 40 W  | 4 400 lm      | 4 × 18 W CFL     | 4 000 K       | > 0.9 | microprismatic | 110 lm/W          | 19    | yes          | 595 × 595 × 10 mm |
| ZR5412E  | 8592920085394 | 40 W  | 4 400 lm      | 2 × 36 W CFL     | 4 000 K       | > 0.9 | milky          | 110 lm/W          | 22    | yes          | 595 × 595 × 10 mm |
| ZR5421E  | 8592920085363 | 40 W  | 4 090 lm      | 4 × 18 W CFL     | 3 000 K       | > 0.9 | microprismatic | 102 lm/W          | 19    | yes          | 595 × 595 × 10 mm |
| ZR5422E  | 8592920085356 | 40 W  | 4 400 lm      | 4 × 18 W CFL     | 4 000 K       | > 0.9 | microprismatic | 110 lm/W          | 19    | yes          | 595 × 595 × 10 mm |

|                   |                                |
|-------------------|--------------------------------|
| Lifetime (L80)    | 30 000 hours                   |
| CRI               | > 80                           |
| Body material     | aluminium                      |
| Diffuser material | plastic (PS)/(PC)              |
| LGP material      | MS                             |
| IP rating         | IP20                           |
| Dimensions        | 595 × 595 mm<br>1 195 × 295 mm |



Photometric data available at [www.emos.eu/LDT](http://www.emos.eu/LDT)

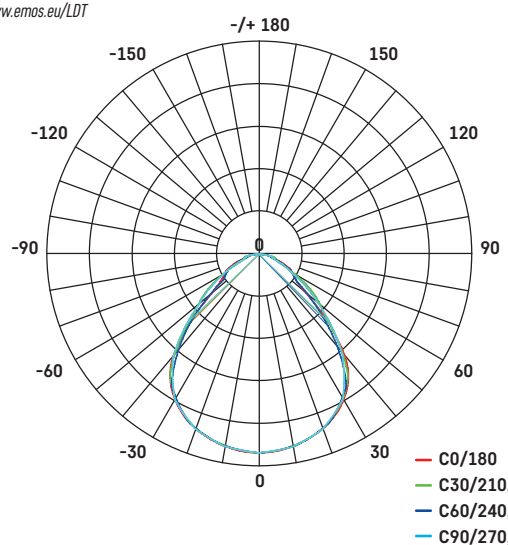

## ZR8412

1/-/-/5

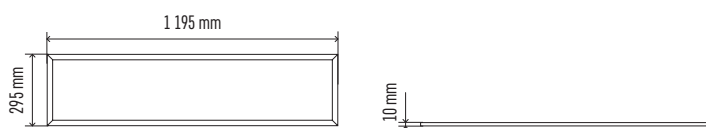

### Set with additional dimmable driver

| Type     | Panel  | Dimmable power supply |
|----------|--------|-----------------------|
| ZR8412DA | ZR8412 | ZZ409BD               |

See page 134

### Set with additional emergency driver

| Type    | Panel  | Emergency power supply |
|---------|--------|------------------------|
| ZR8412E | ZR8412 | ZR9310                 |

See page 127

| Type     | EAN           | Power | Luminous Flux | Equivalent Power | CCT     | PF    | Diffuser Type | Luminous Efficacy | UGR < | Flicker-Free | W × H × D           |
|----------|---------------|-------|---------------|------------------|---------|-------|---------------|-------------------|-------|--------------|---------------------|
| ZR8412   | 8592920076781 | 40 W  | 4 400 lm      | 2 × 36 W CFL     | 4 000 K | > 0.9 | milky         | 110 lm/W          | 22    | yes          | 1 195 × 295 × 10 mm |
| ZR8412DA | 8592920113837 | 40 W  | 4 400 lm      | 2 × 36 W CFL     | 4 000 K | > 0.9 | milky         | 110 lm/W          | 22    | yes          | 1 195 × 295 × 10 mm |
| ZR8412E  | 8592920085370 | 40 W  | 4 400 lm      | 2 × 36 W CFL     | 4 000 K | > 0.9 | milky         | 110 lm/W          | 22    | yes          | 1 195 × 295 × 10 mm |

# DAXXO

LED panels DAXXO are an economical option of indoor lighting. Simple design together with the high quality of light is perfect for offices or classrooms.

**Main benefits:**

- High efficiency and uniformity of emitted light
- Excellent performance and light quality - CRI > 80

**Areas of use:** offices, classrooms, interior spaces

|                   |              |
|-------------------|--------------|
| Lifetime (L80)    | 25 000 hours |
| CRI               | > 80         |
| Body material     | sheet steel  |
| Diffuser material | plastic (PC) |
| IP rating         | IP20         |



Photometric data available at [www.emos.eu/LDT](http://www.emos.eu/LDT)

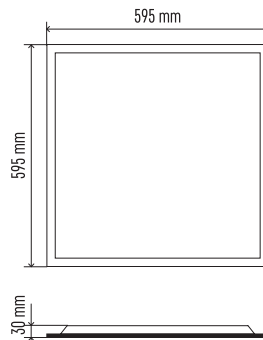
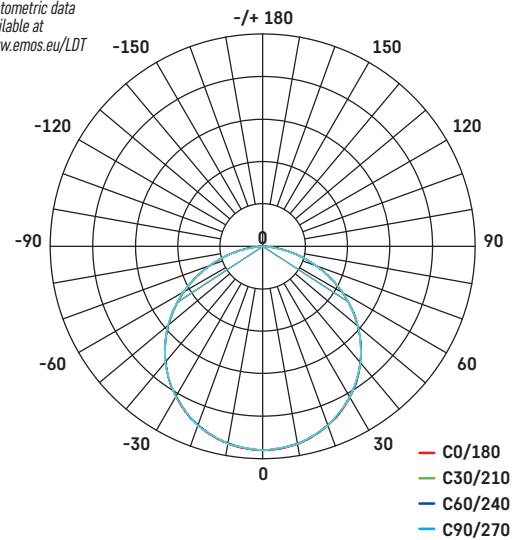

**ZB2414**

1/-/-/6

| Type   | EAN           | Power | Luminous Flux | Equivalent Power | CCT     | PF    | Diffuser Type | Luminous Efficacy | UGR < | Flicker-Free | W × H × D         |
|--------|---------------|-------|---------------|------------------|---------|-------|---------------|-------------------|-------|--------------|-------------------|
| ZB2414 | 8592920119914 | 36 W  | 3 600 lm      | 4 × 18 W CFL     | 4 000 K | > 0.9 | milky         | 100 lm/W          | 22    | yes          | 595 × 595 × 30 mm |

# ACCESSORIES FOR LED PANELS

PROXO and MAXXO LED panels can be installed in a grid as a ceiling luminaire, but also as a ceiling-mounted luminaire with our installation frame or with a set of springs or hooks. With the help of additional accessories, these panels can be hung in space.

**Main benefits:**

- suspended ceiling installation
- fixed installation
- pendant luminaire

**Areas of use:** offices, classrooms and indoor areas.



**ZR9001**

1/-/-/100

**4 SPRINGS**  
for 600 × 600 mm panel (300 mm)  
EAN: 8592920034415



**ZR9002**

1/-/-/100

**6 SPRINGS**  
for 1 200 × 300 mm panel  
EAN: 8592920034439



**ZR9010**

1/-/-/100

**4 HOOKS**  
for 600 × 600 mm panel (300 mm)  
EAN: 8592920034453



**ZR9011**

1/-/-/100

**6 HOOKS**  
for 1 200 × 300 mm panel  
EAN: 8592920034477



**ZR9020**

1/-/-/100

**4 CORDS FOR PENDANT**  
**INSTALLATION LENGTH 5-145 cm**  
for 600 × 600 mm panel (300 mm)  
EAN: 8592920034491



**ZR9021**

1/-/-/100

**6 CORDS FOR PENDANT**  
**INSTALLATION LENGTH 5-145 cm**  
for 1 200 × 300 mm panel  
EAN: 8592920034514



**ZR9034**

1/-/-/20

**FRAME**  
for 600 × 600 mm panel  
screwless  
EAN: 8592920076866



**ZR9035**

1/-/-/15

**FRAME**  
for 300 × 1 200 mm panel  
screwless  
EAN: 8592920076880



**ZR9036**

1/-/-/20

**FRAME**  
for 600 × 600 mm backlit panel  
screwless  
EAN: 8592920106853











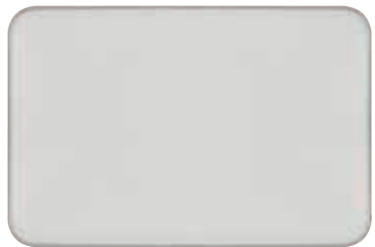

**ZR9041**

1/-/-/100

**REMOTE CONTROLLER**  
for ZR5410  
EAN: 8592920097830

# Room Luminaires

## SURFACE-MOUNTED LUMINAIRES

|              |   |   |  |                      |
|--------------|---|---|--|----------------------|
| ALVI         |    |    |    |                      |
| EXCLUSIVE    | ZM5165  | ZM5166  | ZM5167   | ..... see page 56–57 |
| ILVI         |  |  |  |                      |
| EXCLUSIVE    | ZM5168  | ZM5169  |  | ..... see page 58–59 |
| ILVI GoSmart |  |  |  |                      |
| EXCLUSIVE    | ZM5191  | ZM5192  |  | ..... see page 60–61 |
| RIVI         |  |  |  |                      |
| EXCLUSIVE    | ZM5171  | ZM5172  | ZM5173   | ..... see page 62    |

**IRVI**

**EXCLUSIVE**

ZM5181      ZM5182      ZM5183

..... see page 63

**NEXXO**

**PROFI**

ZM5123    ZM5133    ZM5143    ZM5153    ZM6123    ZM6133    ZM6143    ZM6153

..... see page 64-67

ZM5233    ZM5243    ZM5253    ZM6233    ZM6243    ZM6253

..... see page 68-71

ZM5333    ZM5343    ZM5353    ZM6333    ZM6343    ZM6353

..... see page 72-75

**CORI**

**CLASSIC**

ZM3301    ZM3401    ZM3302    ZM3402    ZM3303    ZM3403    ZM3304    ZM3404

..... see page 76

CORI SENSOR



TORI

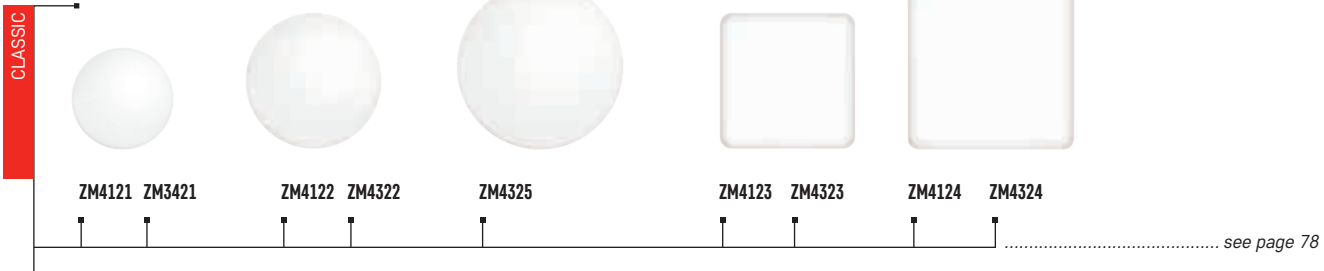

TORI SENSOR

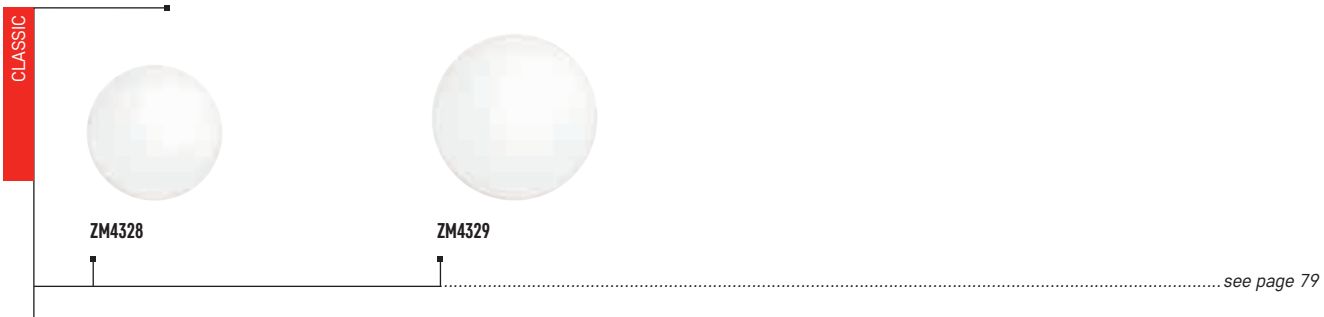

ZURI



ZURI PIR





## DORI

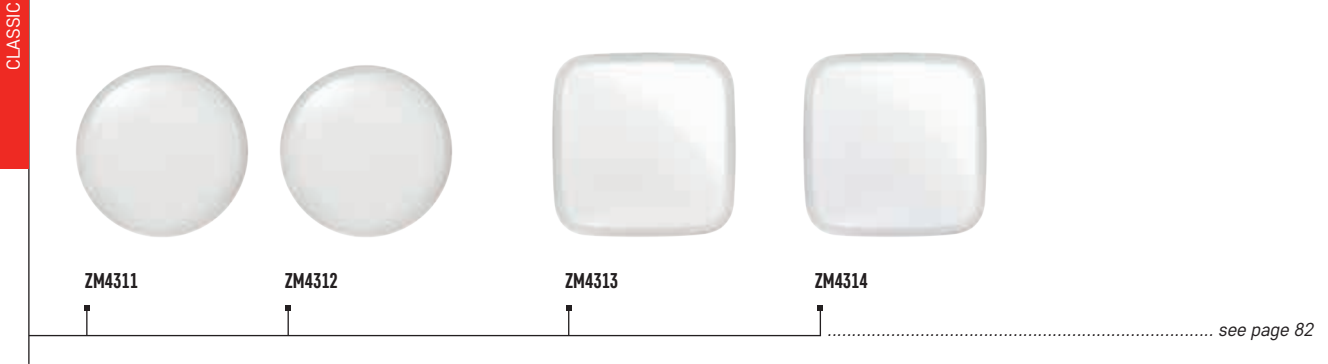

## QARI



## FIORI

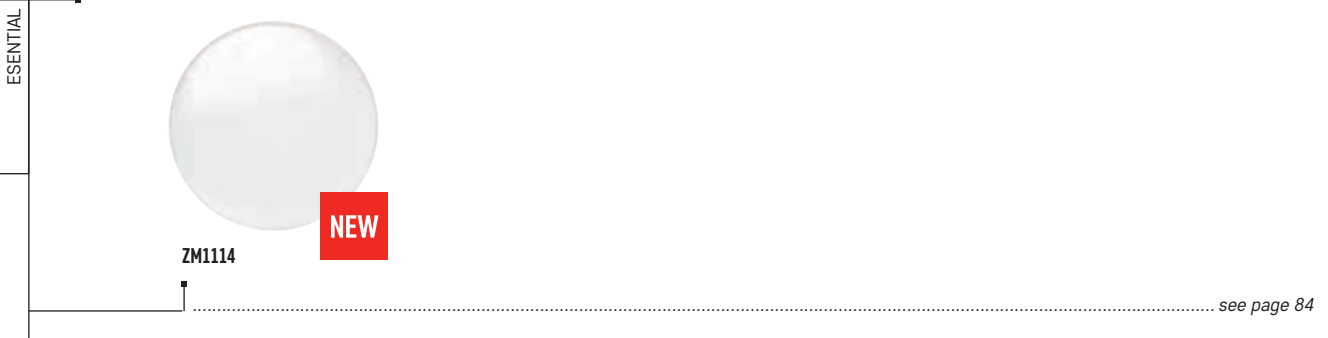

## RUBIC

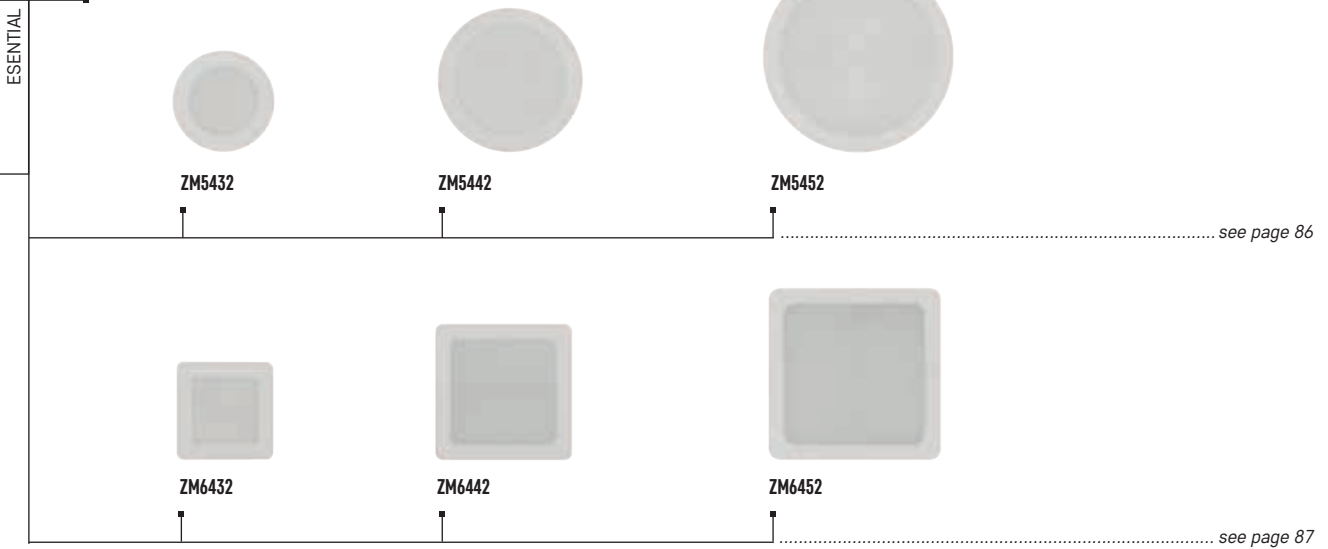

# ALVI

ALVI LED luminaires are modern luminaires of premium quality in a circular shape with very economical and durable LED diodes. Frames in 2 colours (white and silver) are included with the circular models.

#### Main benefits:

- fluent dimming via remote control
- light colour adjustment
- timer and night light function

**Areas of use:** lighting modern interiors in households, offices or hotels.



## ZM5165

1/-/-/5

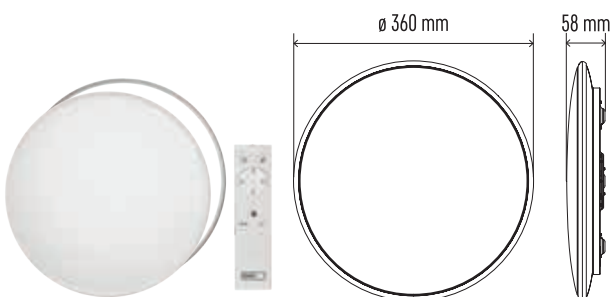

## ZM5166

1/-/-/5

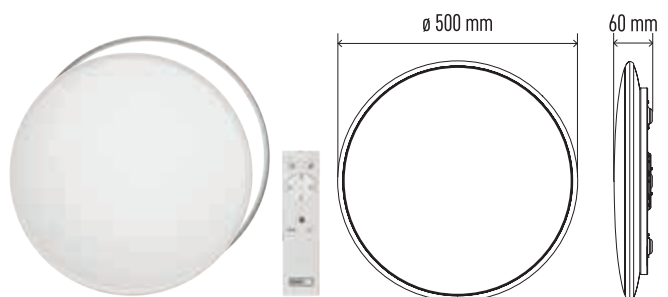

| Type   | EAN           | Power | Luminous Flux | CCT           | PF    | Diameter × D |
|--------|---------------|-------|---------------|---------------|-------|--------------|
| ZM5165 | 8592920089484 | 24 W  | 80-1 920 lm   | 2 700-6 500 K | > 0.5 | 360 × 58 mm  |
| ZM5166 | 8592920089507 | 36 W  | 140-2 880 lm  | 2 700-6 500 K | > 0.9 | 500 × 60 mm  |



WARM WHITE

NEUTRAL WHITE

COOL WHITE

|                   |                |
|-------------------|----------------|
| Lifetime          | 25 000 hours   |
| CRI               | > 80           |
| Body material     | sheet steel    |
| Diffuser material | plastic (PMMA) |
| IP rating         | IP20           |



Photometric data available at [www.emos.eu/LDT](http://www.emos.eu/LDT)

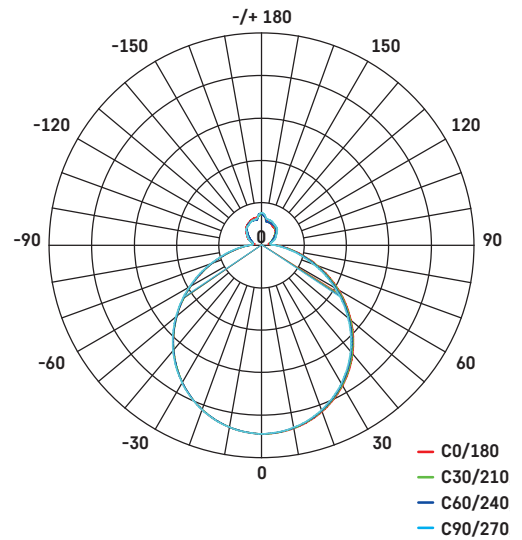
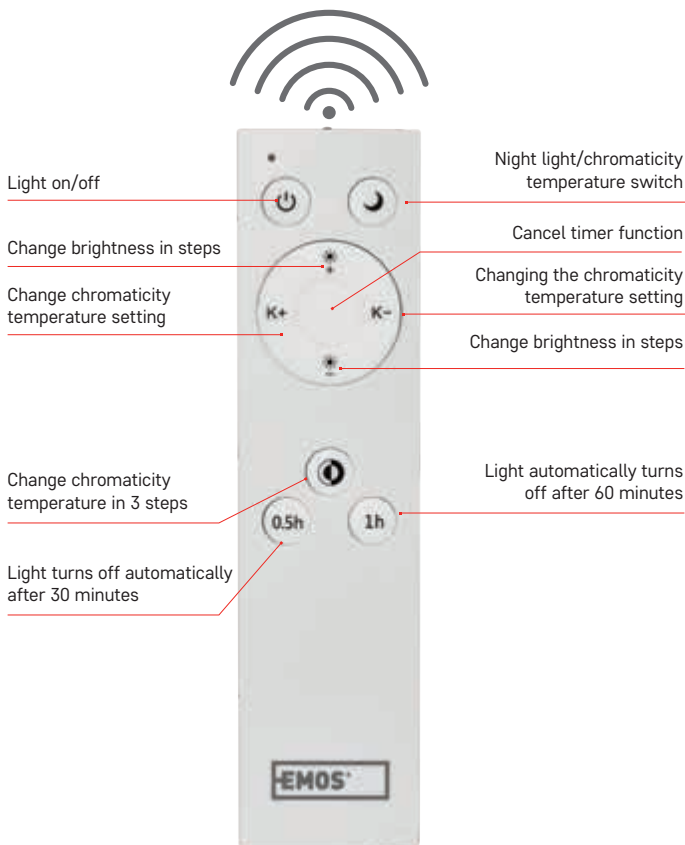

The colour temperature change in steps can also be set using the switch.

## ZM5167

1/-/2

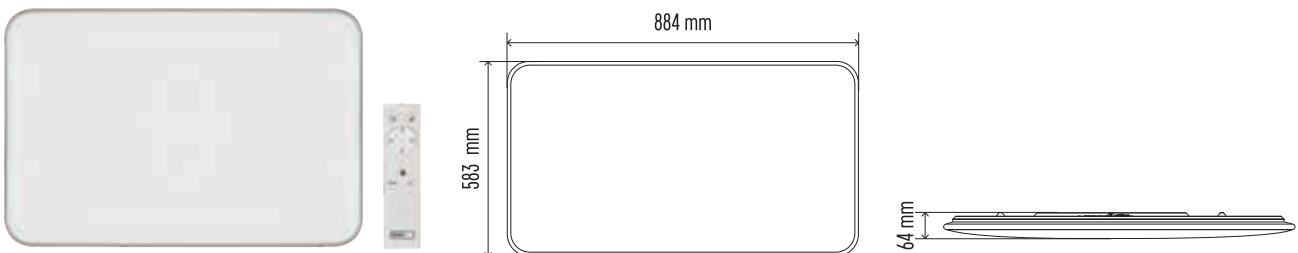

| Type   | EAN           | Power | Luminous Flux | CCT           | PF    | W × H × D         |
|--------|---------------|-------|---------------|---------------|-------|-------------------|
| ZM5167 | 8592920106150 | 72 W  | 5 000 lm      | 2 700-6 500 K | > 0.9 | 884 × 583 × 64 mm |

# ILVI

ILVI LED luminaires are modern and of premium quality in a circular aspect with very economical and durable LEDs.

**Main benefits:**

- fluent dimming via remote control
- light colour adjustment
- timer and night light function

**Areas of use:** lighting of modern interiors in homes, offices or hotels.





WARM WHITE
NEUTRAL WHITE
COOL WHITE

|                   |                            |
|-------------------|----------------------------|
| Lifetime          | 30 000 hours               |
| CRI               | > 80                       |
| Body material     | plastic (PS) + sheet steel |
| Diffuser material | plastic (PMMA)             |
| IP rating         | IP20                       |



Photometric data available at [www.emos.eu/LDT](http://www.emos.eu/LDT)

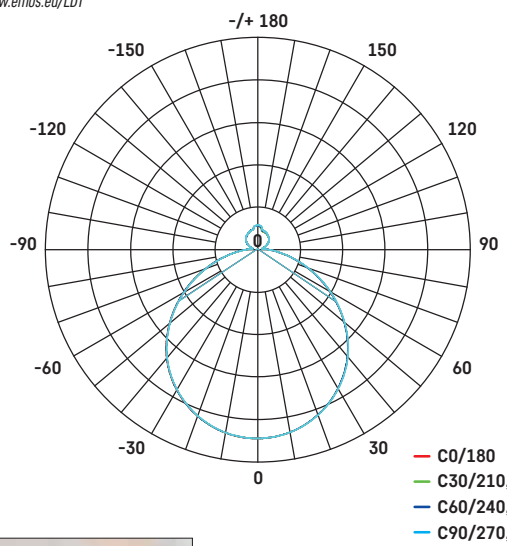

- Light on/off
- Change brightness in steps
- Change chromaticity temperature setting
- Change chromaticity temperature in 3 steps
- Light turns off automatically after 30 minutes
- Night light/chromaticity temperature switch
- Cancel timer function
- Changing the chromaticity temperature setting
- Change brightness in steps
- Light automatically turns off after 60 minutes



The colour temperature change in steps can also be set using the switch.

## ZM5168

1/-/-/5

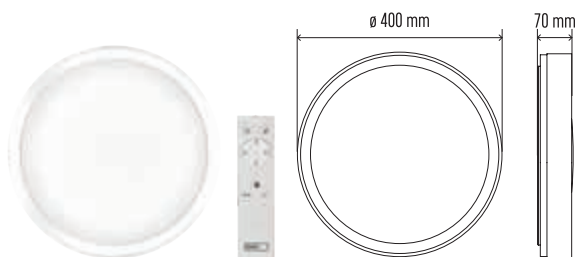

## ZM5169

1/-/-/5

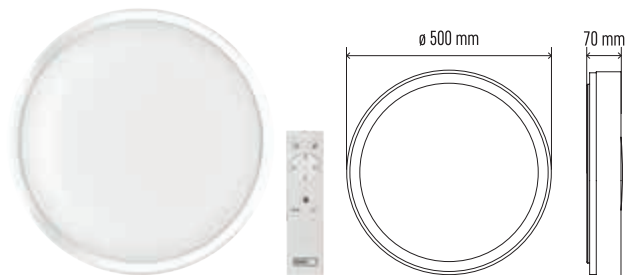

| Type   | EAN           | Power | Luminous Flux | CCT           | PF    | Diameter × D     |
|--------|---------------|-------|---------------|---------------|-------|------------------|
| ZM5168 | 8592920105924 | 30 W  | 180-1 800 lm  | 2 700-6 500 K | > 0.9 | ø 400 mm × 70 mm |
| ZM5169 | 8592920105900 | 45 W  | 270-2 700 lm  | 2 700-6 500 K | > 0.9 | ø 500 mm × 70 mm |

# ILVI GoSmart

LED luminaires ILVI of the EMOS GoSmart series are modern premium quality luminaires of a circular shape that can be conveniently controlled remotely from a smartphone app or with the supplied remote control.

**Main benefits:**

- possible connectivity with other smart home devices
- continuous dimming, light colour adjustment
- timer and night light function

**Areas of use:** lighting of modern interiors in homes, offices or hotels.



EMOS GoSmart





WARM WHITE
NEUTRAL WHITE
COOL WHITE

|                   |                |
|-------------------|----------------|
| Lifetime          | 30 000 hours   |
| CRI               | > 80           |
| Body material     | sheet steel    |
| Diffuser material | plastic (PMMA) |
| IP rating         | IP20           |



Photometric data available at [www.emos.eu/LDT](http://www.emos.eu/LDT)

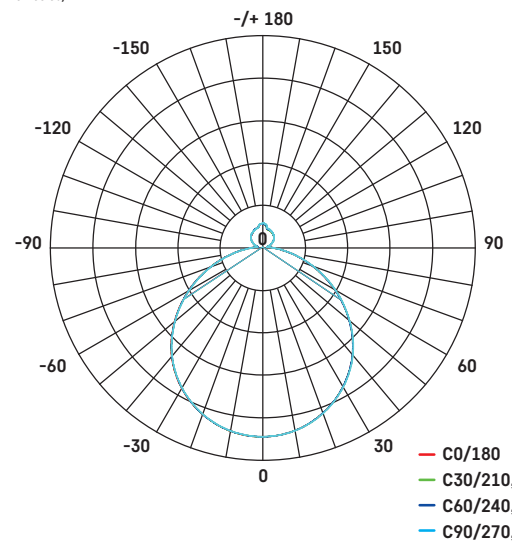

## ZM5191

1/-/1/1

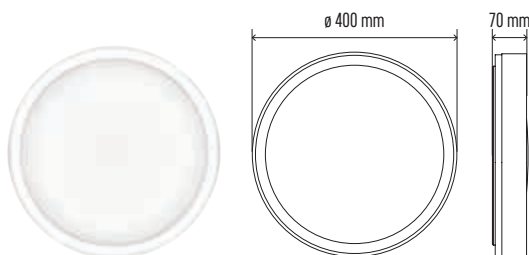

## ZM5192

1/-/1/1

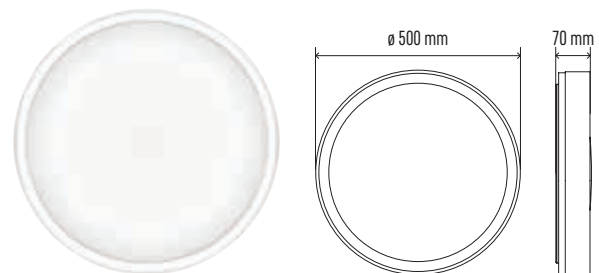

| Type   | EAN           | Power | Luminous Flux | CCT           | PF    | Diameter × D     |
|--------|---------------|-------|---------------|---------------|-------|------------------|
| ZM5191 | 8592920122570 | 30 W  | 1 800 lm      | 2 700–6 500 K | > 0.9 | ø 400 mm × 70 mm |
| ZM5192 | 8592920122587 | 45 W  | 2 700 lm      | 2 700–6 500 K | > 0.9 | ø 500 mm × 70 mm |

# RIVI

RIVI LED luminaires are modern and of premium quality that can be dimmed progressively by remote control. An additional feature of the luminaire, is the ability to create and easily control groups of luminaires.

**Main benefits:**

- four preset light scenes
- continuous dimming and light colour adjustment

**Areas of use:** lighting of modern interiors in homes, offices or hotels.



|                   |              |
|-------------------|--------------|
| Lifetime          | 30 000 hours |
| CRI               | > 80         |
| Body material     | aluminium    |
| Diffuser material | plastic (PC) |
| IP rating         | IP20         |



Photometric data available at [www.emos.eu/LDT](http://www.emos.eu/LDT)

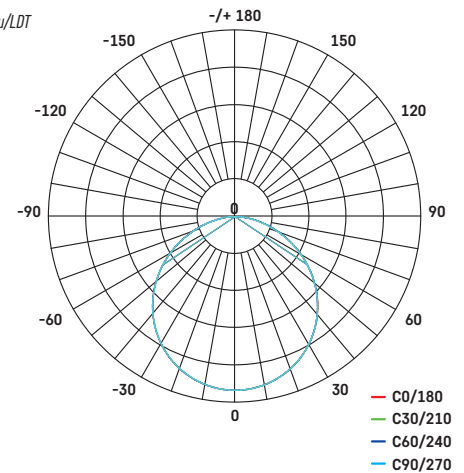

**ZM5171**

1/-/-/3

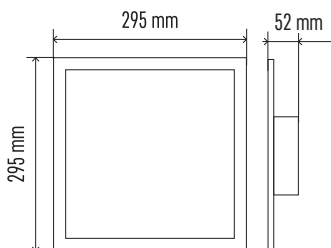

**ZM5172**

1/-/-/4

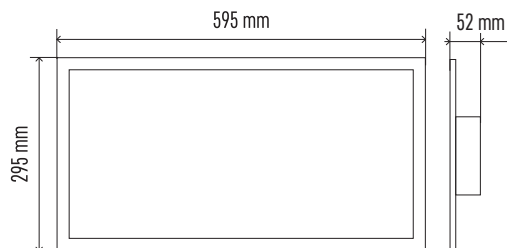

**ZM5173**

1/-/-/4

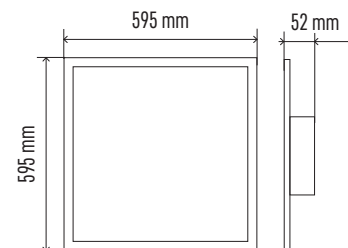

| Type   | EAN           | Power | Luminous Flux | CCT           | PF    | W × H × D         |
|--------|---------------|-------|---------------|---------------|-------|-------------------|
| ZM5171 | 8592920090442 | 20 W  | 140-1 400 lm  | 2 700-6 000 K | > 0.9 | 295 × 295 × 52 mm |
| ZM5172 | 8592920090466 | 25 W  | 210-2 100 lm  | 2 700-6 000 K | > 0.9 | 595 × 295 × 52 mm |
| ZM5173 | 8592920090480 | 40 W  | 380-3 800 lm  | 2 700-6 000 K | > 0.9 | 595 × 595 × 52 mm |



## IRVI

IRVI LED luminaires are elegant frameless luminaires that can be dimmed progressively by remote control. Thanks to their superior light quality, they are designed to illuminate spaces where accurate colour rendering is required. An additional feature of the luminaire is the ability to create and easily control groups of luminaires.

### Main benefits:

- high colour rendering index
- four preset light scenes
- smooth dimming and light colour adjustment

**Areas of use:** lighting of modern interiors in homes, offices or hotels.



WARM WHITE

NEUTRAL WHITE

COOL WHITE



**ZM5181**

1/-/-/3

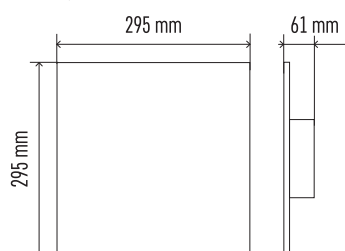

**ZM5182**

1/-/-/4

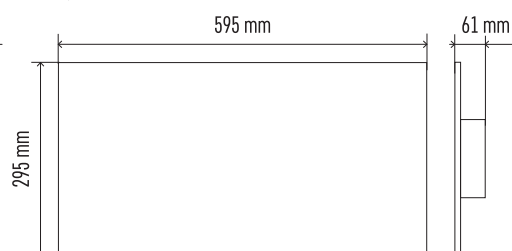

**ZM5183**

1/-/-/3

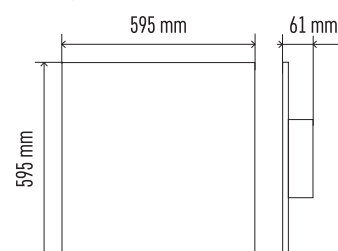

|                   |              |
|-------------------|--------------|
| Lifetime          | 30 000 hours |
| CRI               | > 95         |
| Body material     | aluminium    |
| Diffuser material | plastic (PC) |
| IP rating         | IP20         |



Photometric data available at [www.emos.eu/LDT](http://www.emos.eu/LDT)

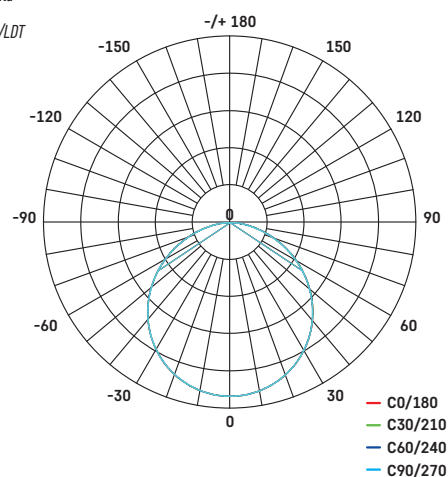

| Type   | EAN           | Power | Luminous Flux | CCT           | PF    | W × H × D         |
|--------|---------------|-------|---------------|---------------|-------|-------------------|
| ZM5181 | 8592920090503 | 18 W  | 125–1 250 lm  | 2 700–6 000 K | > 0.9 | 295 × 295 × 61 mm |
| ZM5182 | 8592920090527 | 24 W  | 190–1 900 lm  | 2 700–6 000 K | > 0.9 | 595 × 295 × 61 mm |
| ZM5183 | 8592920090541 | 36 W  | 305–3 050 lm  | 2 700–6 000 K | > 0.9 | 595 × 595 × 61 mm |

# NEXXO

Practical NEXXO circular LED luminaires in white are made of sheet steel and acrylic glass. The luminaires are designed for surface mounting where the desired light temperature can be selected.

## Main benefits:

- the possibility of selecting the light temperature during installation
- high quality LIFUD drivers
- LGP – PMMA – pleasantly diffused light
- easy installation thanks to the installation console

**Areas of use:** lighting of modern interiors in homes, offices or hotels.

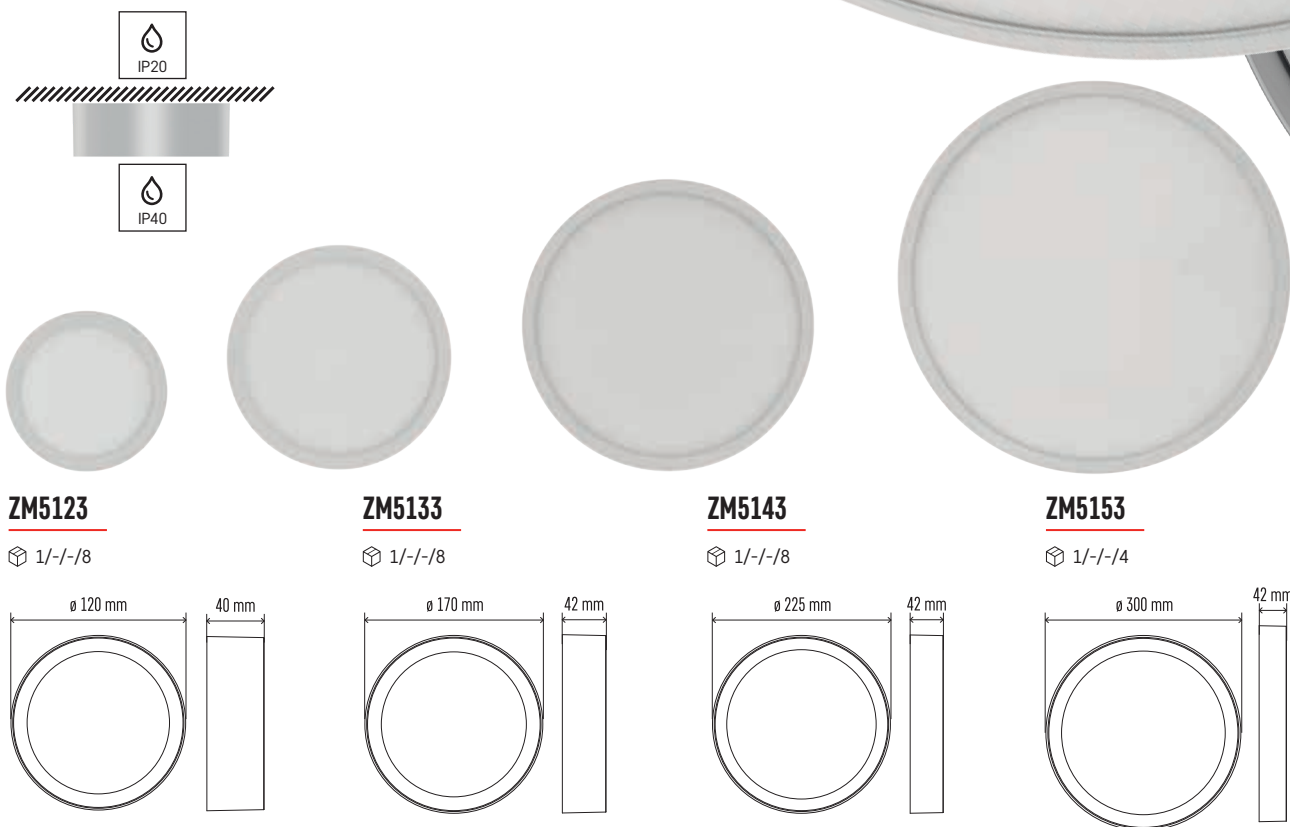

### ZM5123

1/-/-/8

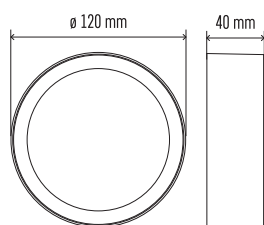

### ZM5133

1/-/-/8

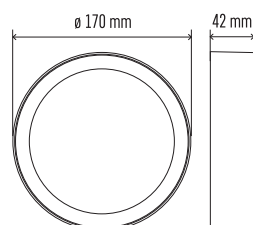

### ZM5143

1/-/-/8

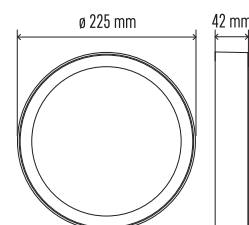

### ZM5153

1/-/-/4

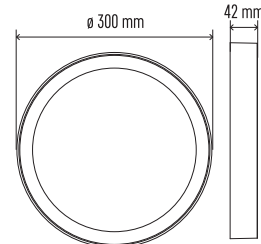

| Type    | EAN           | Power  | Luminous Flux | CCT                 | PF    | Diameter × D     |
|---------|---------------|--------|---------------|---------------------|-------|------------------|
| ZM5123  | 8592920109212 | 7.6 W  | 680 lm        | 3 000/3 500/4 000 K | > 0.5 | ø 120 mm × 40 mm |
| ZM5133  | 8592920109250 | 12.5 W | 1 100 lm      | 3 000/3 500/4 000 K | > 0.5 | ø 170 mm × 42 mm |
| ZM5143  | 8592920109281 | 21 W   | 1 900 lm      | 3 000/3 500/4 000 K | > 0.9 | ø 225 mm × 42 mm |
| ZM5153  | 8592920109328 | 28.5 W | 2 700 lm      | 3 000/3 500/4 000 K | > 0.9 | ø 300 mm × 42 mm |
| ZM5133T | 8592920113936 | 12.5 W | 1 100 lm      | 3 000/3 500/4 000 K | > 0.5 | ø 170 mm × 42 mm |
| ZM5143T | 8592920113943 | 21 W   | 1 900 lm      | 3 000/3 500/4 000 K | > 0.9 | ø 225 mm × 42 mm |
| ZM5153T | 8592920113950 | 28.5 W | 2 700 lm      | 3 000/3 500/4 000 K | > 0.9 | ø 300 mm × 42 mm |



|                   |                |
|-------------------|----------------|
| Lifetime          | 30 000 hours   |
| CRI               | > 80           |
| Body material     | sheet steel    |
| Diffuser material | plastic (PMMA) |
| LGP material      | PMMA           |
| IP rating         | IP40/IP20      |



Photometric data available at [www.emos.eu/LDT](http://www.emos.eu/LDT)

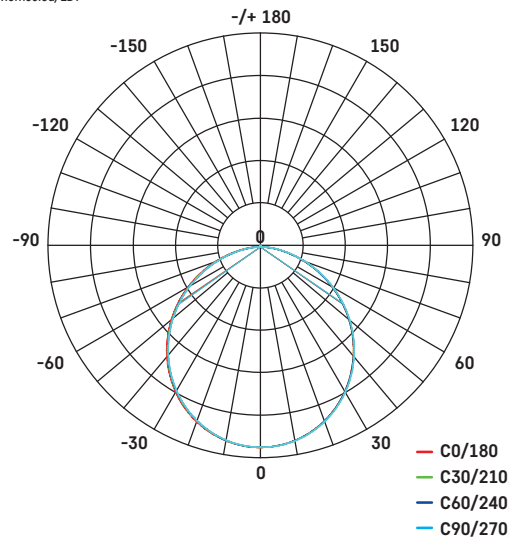

- 3 000 K
- 3 500 K
- 4 000 K



Adjustable during installation



**Set with additional dimmable driver**

| Type    | Panel  | + | Dimmable power supply |
|---------|--------|---|-----------------------|
| ZM5133T | ZM5133 | + | ZZ1435T               |
| ZM5143T | ZM5143 | + | ZZ2055T               |
| ZM5153T | ZM5153 | + | ZZ3070T               |

See page 134

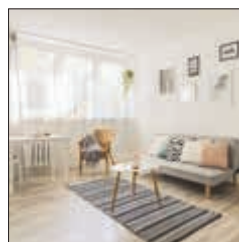

3 000 K



3 500 K



4 000 K

# NEXXO

Practical NEXXO square LED luminaires in white are made of sheet steel and acrylic glass. The luminaires are designed for surface mounting where the desired light temperature can be selected.

## Main benefits:

- the possibility of selecting the light temperature during installation
- high quality LIFUD drivers
- LGP – PMMA – pleasantly diffused light
- easy installation thanks to the installation console

**Areas of use:** lighting of modern interiors in homes, offices or hotels.

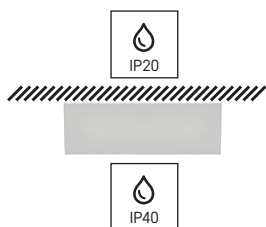

### ZM6123

1/-/-8

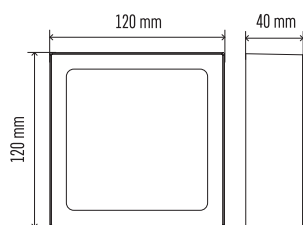

### ZM6133

1/-/-8

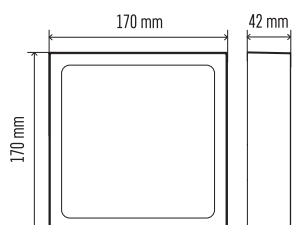

### ZM6143

1/-/-8

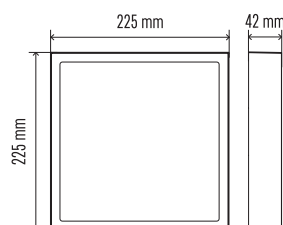

### ZM6153

1/-/-4

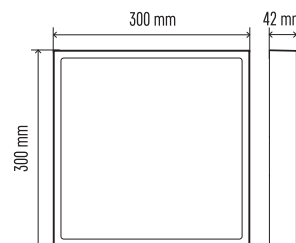

| Type    | EAN           | Power  | Luminous Flux | CCT                 | PF    | W × H × D         |
|---------|---------------|--------|---------------|---------------------|-------|-------------------|
| ZM6123  | 8592920109298 | 7.6 W  | 680 lm        | 3 000/3 500/4 000 K | > 0.5 | 120 × 120 × 40 mm |
| ZM6133  | 8592920109243 | 12.5 W | 1 100 lm      | 3 000/3 500/4 000 K | > 0.5 | 170 × 170 × 42 mm |
| ZM6143  | 8592920109205 | 21 W   | 1 900 lm      | 3 000/3 500/4 000 K | > 0.9 | 225 × 225 × 42 mm |
| ZM6153  | 8592920109144 | 28.5 W | 2 700 lm      | 3 000/3 500/4 000 K | > 0.9 | 300 × 300 × 42 mm |
| ZM6133T | 8592920113967 | 12.5 W | 1 100 lm      | 3 000/3 500/4 000 K | > 0.5 | 170 × 170 × 42 mm |
| ZM6143T | 8592920113974 | 21 W   | 1 900 lm      | 3 000/3 500/4 000 K | > 0.9 | 225 × 225 × 42 mm |
| ZM6153T | 8592920113981 | 28.5 W | 2 700 lm      | 3 000/3 500/4 000 K | > 0.9 | 300 × 300 × 42 mm |

|                   |                |
|-------------------|----------------|
| Lifetime          | 30 000 hours   |
| CRI               | > 80           |
| Body material     | sheet steel    |
| Diffuser material | plastic (PMMA) |
| LGP material      | PMMA           |
| IP rating         | IP40/IP20      |



Photometric data available at [www.emos.eu/LDT](http://www.emos.eu/LDT)

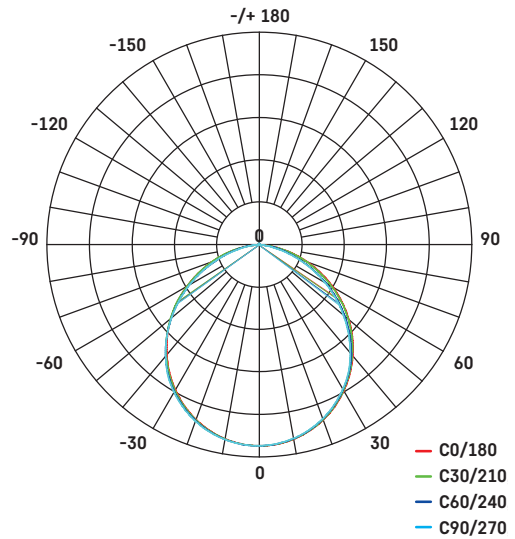

- 3 000 K
- 3 500 K
- 4 000 K



Adjustable during installation



**Set with additional dimmable driver**

| Type    | Panel      | Dimmable power supply |
|---------|------------|-----------------------|
| ZM6133T | = ZM6133 + | ZZ1435T               |
| ZM6143T | = ZM6143 + | ZZ2055T               |
| ZM6153T | = ZM6153 + | ZZ3070T               |

See page 134



3 000 K



3 500 K



4 000 K

# NEXXO

The practical NEXXO circular LED luminaires in brushed nickel are made of sheet steel and acrylic glass. The luminaires are designed for surface mounting where the desired light temperature can be selected.

## Main benefits:

- selection of light temperature during installation
- high quality LIFUD drivers
- LGP – PMMA – pleasantly diffused light
- easy installation thanks to the installation console

**Areas of use:** lighting of modern interiors in homes, offices or hotels.

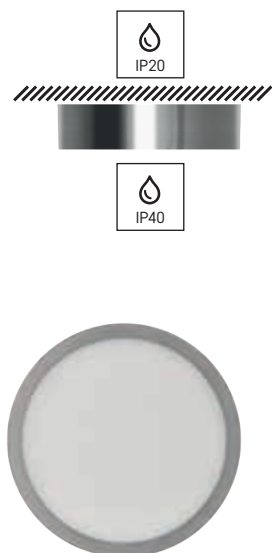

## ZM5233

1/-/-/8

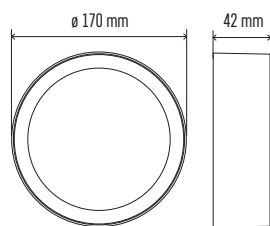

## ZM5243

1/-/-/8

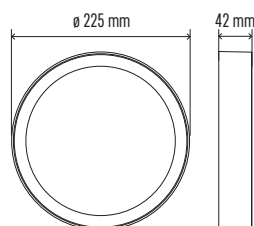

## ZM5253

1/-/-/4

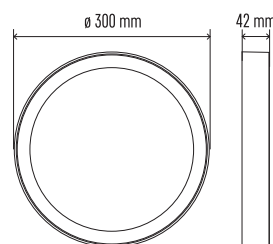

| Type    | EAN           | Power  | Luminous Flux | CCT                 | PF    | Diameter × D     |
|---------|---------------|--------|---------------|---------------------|-------|------------------|
| ZM5233  | 8592920109359 | 12.5 W | 1 100 lm      | 3 000/3 500/4 000 K | > 0.5 | ø 170 mm × 42 mm |
| ZM5243  | 8592920109403 | 21 W   | 1 900 lm      | 3 000/3 500/4 000 K | > 0.9 | ø 225 mm × 42 mm |
| ZM5253  | 8592920109434 | 28.5 W | 2 700 lm      | 3 000/3 500/4 000 K | > 0.9 | ø 300 mm × 42 mm |
| ZM5233T | 8592920113998 | 12.5 W | 1 100 lm      | 3 000/3 500/4 000 K | > 0.5 | ø 170 mm × 42 mm |
| ZM5243T | 8592920114001 | 21 W   | 1 900 lm      | 3 000/3 500/4 000 K | > 0.9 | ø 225 mm × 42 mm |
| ZM5253T | 8592920114018 | 28.5 W | 2 700 lm      | 3 000/3 500/4 000 K | > 0.9 | ø 300 mm × 42 mm |



|                   |                |
|-------------------|----------------|
| Lifetime          | 30 000 hours   |
| CRI               | > 80           |
| Body material     | sheet steel    |
| Diffuser material | plastic (PMMA) |
| LGP material      | PMMA           |
| IP rating         | IP40/IP20      |



Photometric data available at [www.emos.eu/LDT](http://www.emos.eu/LDT)

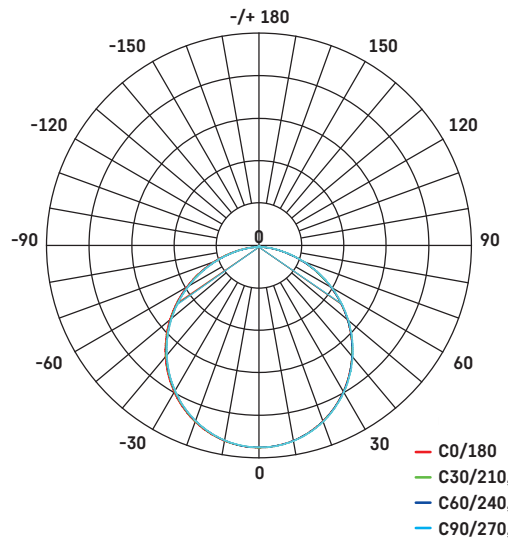

- 3 000 K
- 3 500 K
- 4 000 K



Adjustable during installation



**Set with additional dimmable driver**

| Type    | Panel      | Dimmable power supply |
|---------|------------|-----------------------|
| ZM5233T | = ZM5233 + | ZZ1435T               |
| ZM5243T | = ZM5243 + | ZZ2055T               |
| ZM5253T | = ZM5253 + | ZZ3070T               |

See page 134

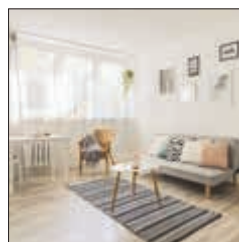

3 000 K



3 500 K



4 000 K

# NEXXO

Practical square LED luminaires NEXXO made of brushed nickel are made of sheet steel and acrylic glass. The luminaires are designed for surface mounting, where the required light temperature can be selected.

## Main benefits:

- selection of light temperature during installation
- high quality LIFUD drivers
- LGP – PMMA – pleasantly diffused light
- easy installation thanks to the installation console

**Areas of use:** lighting of modern interiors in homes, offices or hotels.



### ZM6233

1/-/-/8

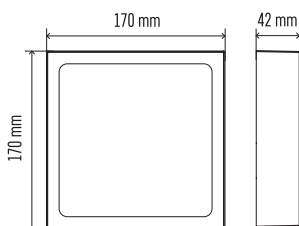

### ZM6243

1/-/-/8

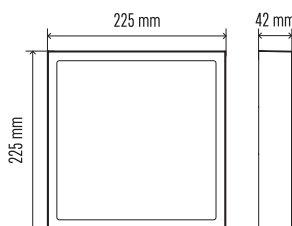

### ZM6253

1/-/-/4

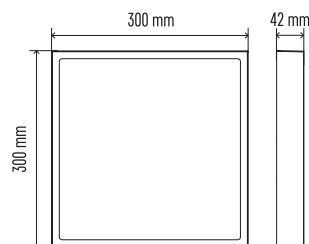

| Type    | EAN           | Power  | Luminous Flux | CCT                 | PF    | W × H × D         |
|---------|---------------|--------|---------------|---------------------|-------|-------------------|
| ZM6233  | 8592920109090 | 12.5 W | 1 100 lm      | 3 000/3 500/4 000 K | > 0.5 | 170 × 170 × 42 mm |
| ZM6243  | 8592920109038 | 21 W   | 1 900 lm      | 3 000/3 500/4 000 K | > 0.9 | 225 × 225 × 42 mm |
| ZM6253  | 8592920108987 | 28.5 W | 2 700 lm      | 3 000/3 500/4 000 K | > 0.9 | 300 × 300 × 42 mm |
| ZM6233T | 8592920114025 | 12.5 W | 1 100 lm      | 3 000/3 500/4 000 K | > 0.5 | 170 × 170 × 42 mm |
| ZM6243T | 8592920114032 | 21 W   | 1 900 lm      | 3 000/3 500/4 000 K | > 0.9 | 225 × 225 × 42 mm |
| ZM6253T | 8592920114049 | 28.5 W | 2 700 lm      | 3 000/3 500/4 000 K | > 0.9 | 300 × 300 × 42 mm |





|                   |                |
|-------------------|----------------|
| Lifetime          | 30 000 hours   |
| CRI               | > 80           |
| Body material     | sheet steel    |
| Diffuser material | plastic (PMMA) |
| LGP material      | PMMA           |
| IP rating         | IP40/IP20      |



Photometric data available at [www.emos.eu/LDT](http://www.emos.eu/LDT)

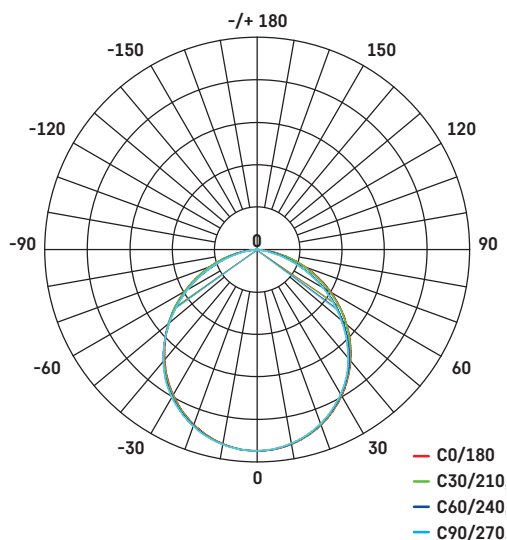

- 3 000 K
- 3 500 K
- 4 000 K



Adjustable during installation



### Set with additional dimmable driver

| Type    | Panel      | Dimmable power supply |
|---------|------------|-----------------------|
| ZM6233T | = ZM6233 + | ZZ1435T               |
| ZM6243T | = ZM6243 + | ZZ2055T               |
| ZM6253T | = ZM6253 + | ZZ3070T               |

See page 134

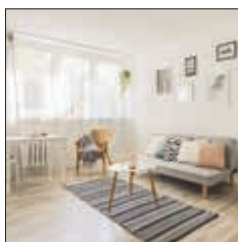

3 000 K



3 500 K



4 000 K

# NEXXO

The practical NEXXO LED luminaires with their circular shape and sand black colour are made of sheet steel and acrylic glass. The luminaires are designed for surface mounting where the desired light temperature can be selected.

## Main benefits:

- selection of light temperature during installation
- high quality LIFUD drivers
- LGP – PMMA – pleasantly diffused light
- easy installation thanks to the installation console

**Areas of use:** lighting of modern interiors in homes, offices or hotels.



## ZM5333

1/-/-/8

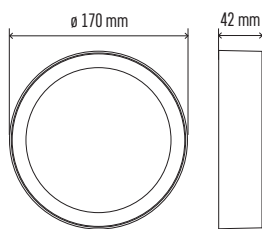

## ZM5343

1/-/-/8

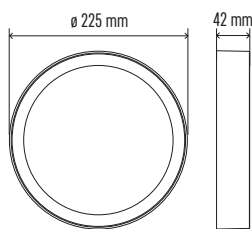

## ZM5353

1/-/-/4

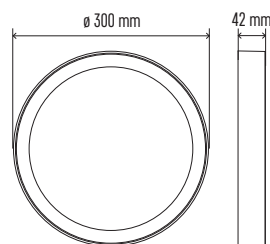

| Type    | EAN           | Power  | Luminous Flux | CCT                 | PF    | Diameter × D     |
|---------|---------------|--------|---------------|---------------------|-------|------------------|
| ZM5333  | 8592920109410 | 12.5 W | 1 100 lm      | 3 000/3 500/4 000 K | > 0.5 | ø 170 mm × 42 mm |
| ZM5343  | 8592920109380 | 21 W   | 1 900 lm      | 3 000/3 500/4 000 K | > 0.9 | ø 225 mm × 42 mm |
| ZM5353  | 8592920109342 | 28.5 W | 2 700 lm      | 3 000/3 500/4 000 K | > 0.9 | ø 300 mm × 42 mm |
| ZM5333T | 8592920114056 | 12.5 W | 1 100 lm      | 3 000/3 500/4 000 K | > 0.5 | ø 170 mm × 42 mm |
| ZM5343T | 8592920114063 | 21 W   | 1 900 lm      | 3 000/3 500/4 000 K | > 0.9 | ø 225 mm × 42 mm |
| ZM5353T | 8592920114070 | 28.5 W | 2 700 lm      | 3 000/3 500/4 000 K | > 0.9 | ø 300 mm × 42 mm |



|                   |                |
|-------------------|----------------|
| Lifetime          | 30 000 hours   |
| CRI               | > 80           |
| Body material     | sheet steel    |
| Diffuser material | plastic (PMMA) |
| LGP material      | PMMA           |
| IP rating         | IP40/IP20      |



Photometric data available at [www.emos.eu/LDT](http://www.emos.eu/LDT)

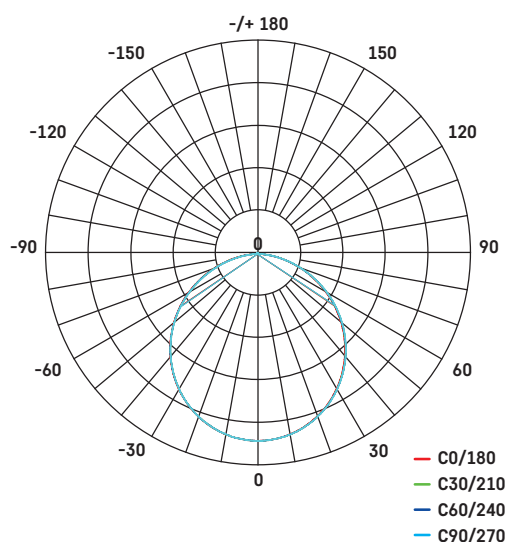

- 3 000 K
- 3 500 K
- 4 000 K



Adjustable during installation



### Set with additional dimmable driver

| Type    | Panel  | + | Dimmable power supply |
|---------|--------|---|-----------------------|
| ZM5333T | ZM5333 | + | ZZ1435T               |
| ZM5343T | ZM5343 | + | ZZ2055T               |
| ZM5353T | ZM5353 | + | ZZ3070T               |

See page 134



3 000 K



3 500 K

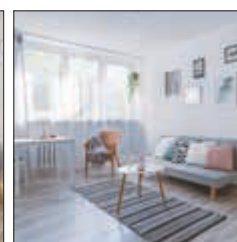

4 000 K

# NEXXO

The practical NEXXO LED luminaires with their square shape and sand black colour are made of sheet steel and acrylic glass. The luminaires are designed for surface mounting where the desired light temperature can be selected.

## Main benefits:

- selection of light temperature during installation
- high quality LIFUD drivers
- LGP – PMMA – pleasantly diffused light
- easy installation thanks to the installation console

**Areas of use:** lighting of modern interiors in homes, offices or hotels.



### ZM6333

1/-/-/8

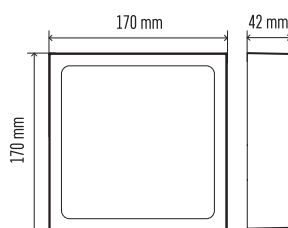

### ZM6343

1/-/-/8

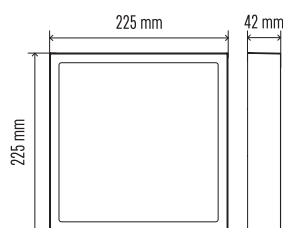

### ZM6353

1/-/-/4

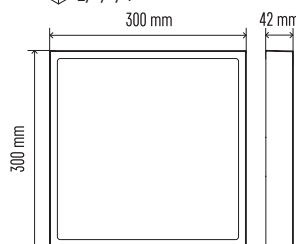

| Type    | EAN           | Power  | Luminous Flux | CCT                 | PF    | W × H × D         |
|---------|---------------|--------|---------------|---------------------|-------|-------------------|
| ZM6333  | 8592920108949 | 12.5 W | 1 100 lm      | 3 000/3 500/4 000 K | > 0.5 | 170 × 170 × 42 mm |
| ZM6343  | 8592920108901 | 21 W   | 1 900 lm      | 3 000/3 500/4 000 K | > 0.9 | 225 × 225 × 42 mm |
| ZM6353  | 8592920108864 | 28.5 W | 2 700 lm      | 3 000/3 500/4 000 K | > 0.9 | 300 × 300 × 42 mm |
| ZM6333T | 8592920114087 | 12.5 W | 1 100 lm      | 3 000/3 500/4 000 K | > 0.5 | 170 × 170 × 42 mm |
| ZM6343T | 8592920114094 | 21 W   | 1 900 lm      | 3 000/3 500/4 000 K | > 0.9 | 225 × 225 × 42 mm |
| ZM6353T | 8592920114100 | 28.5 W | 2 700 lm      | 3 000/3 500/4 000 K | > 0.9 | 300 × 300 × 42 mm |



|                   |                |
|-------------------|----------------|
| Lifetime          | 30 000 hours   |
| CRI               | > 80           |
| Body material     | sheet steel    |
| Diffuser material | plastic (PMMA) |
| LGP material      | PMMA           |
| IP rating         | IP40/IP20      |



Photometric data available at [www.emos.eu/LDT](http://www.emos.eu/LDT)

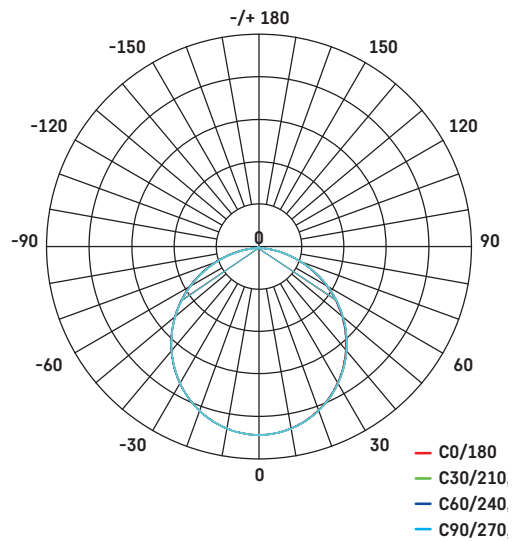

- 3 000 K
- 3 500 K
- 4 000 K



Adjustable during installation



**Set with additional dimmable driver**

| Type    | Panel      | Dimmable power supply |
|---------|------------|-----------------------|
| ZM6333T | = ZM6333 + | ZZ1435T               |
| ZM6343T | = ZM6343 + | ZZ2055T               |
| ZM6353T | = ZM6353 + | ZZ3070T               |

See page 134



3 000 K



3 500 K



4 000 K

# CORI

Timeless LED wall/ceiling luminaires CORI combine pleasant lighting and energy savings in one. The cover of the luminaire is made of high-quality PMMA, mounted on a steel body.

**Main benefits:**

- high luminous efficacy
- conservative design
- integrated driver

**Areas of use:** illumination of modern interiors, areas and hallways in offices, hotels and households.



**ZM3301**

1/-/-/2



**ZM3401**

1/-/-/2



**ZM3302**

1/-/-/2



**ZM3402**

1/-/-/2



**ZM3303**

1/-/-/6



**ZM3403**

1/-/-/6

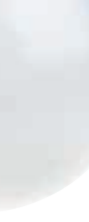

**ZM3304**

1/-/-/6



**ZM3404**

1/-/-/6

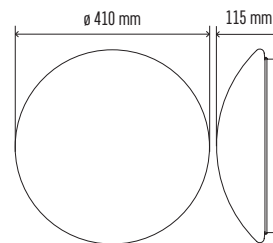
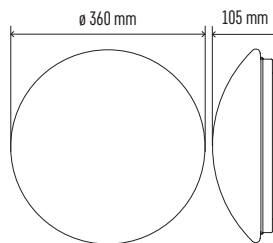
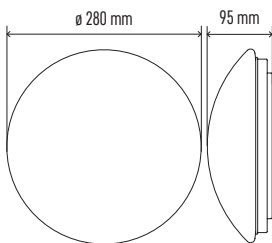

| Type   | EAN           | Power | Luminous Flux | CCT     | PF    | Diameter × D      |
|--------|---------------|-------|---------------|---------|-------|-------------------|
| ZM3301 | 8592920038505 | 12 W  | 925 lm        | 3 000 K | > 0.5 | ø 280 mm × 95 mm  |
| ZM3302 | 8592920038529 | 18 W  | 1 390 lm      | 3 000 K | > 0.5 | ø 360 mm × 105 mm |
| ZM3303 | 8592920038734 | 22 W  | 1 760 lm      | 3 000 K | > 0.5 | ø 410 mm × 115 mm |
| ZM3304 | 8592920038758 | 32 W  | 2 560 lm      | 3 000 K | > 0.5 | ø 410 mm × 115 mm |
| ZM3401 | 8592920038543 | 12 W  | 1 020 lm      | 4 000 K | > 0.5 | ø 280 mm × 95 mm  |
| ZM3402 | 8592920038567 | 18 W  | 1 530 lm      | 4 000 K | > 0.5 | ø 360 mm × 105 mm |
| ZM3403 | 8592920038581 | 22 W  | 1 980 lm      | 4 000 K | > 0.5 | ø 410 mm × 115 mm |
| ZM3404 | 8592920038604 | 32 W  | 2 880 lm      | 4 000 K | > 0.5 | ø 410 mm × 115 mm |

# CORI SENSOR

The luminaires are fitted with a microwave motion detector and allow the user to set the luminaire's daylight sensor and lighting duration after sensor activation.

**Main benefits:**

- high luminous efficacy
- conservative design
- integrated driver

**Areas of use:** illumination of modern interiors, areas and hallways in offices, hotels and households.



|                   |                |
|-------------------|----------------|
| Lifetime          | 30 000 hours   |
| CRI               | > 80           |
| Body material     | sheet steel    |
| Diffuser material | plastic (PMMA) |
| IP rating         | IP44           |



Photometric data available at [www.emos.eu/LDT](http://www.emos.eu/LDT)

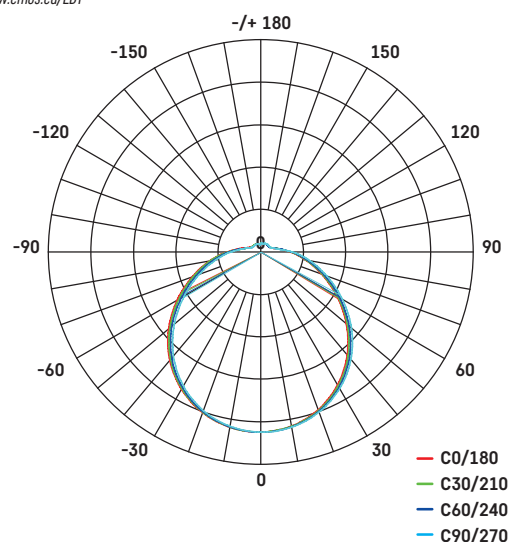

Light source



**ZM3412**

1/-/-/2

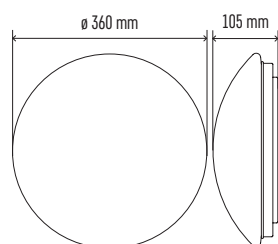

**ZM3413**

1/-/-/6

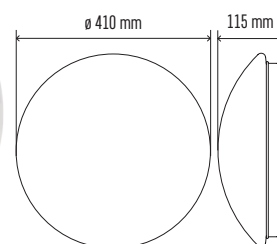

| Type   | EAN           | Power | Luminous Flux | CCT     | PF    | Detection Angle                                       | Detection Range | Time Setting  | Diameter x D      |
|--------|---------------|-------|---------------|---------|-------|---|-----------------|---------------|-------------------|
| ZM3412 | 8592920038628 | 18 W  | 1 530 lm      | 4 000 K | > 0.5 | 150° – when wall-mounted, 360° – when ceiling-mounted | 6 m             | 5 s to 30 min | ø 360 mm x 105 mm |
| ZM3413 | 8592920038642 | 22 W  | 1 980 lm      | 4 000 K | > 0.5 | 150° – when wall-mounted, 360° – when ceiling-mounted | 6 m             | 5 s to 30 min | ø 410 mm x 115 mm |

# TORI

The elegant TORI LED luminaires are an economical variant of pendant luminaires in combination with high quality workmanship. The luminaires are available in two shapes.

**Main benefits:**

- excellent price/quality ratio
- IP44 enclosure ensures water resistance
- easy installation

**Areas of use:** lighting hallways in households, garages and technical spaces.



**ZM4121**

1/-/-/10

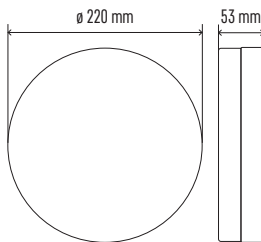

**ZM4321**

1/-/-/10

**ZM4122**

1/-/-/4

**ZM4322**

1/-/-/4

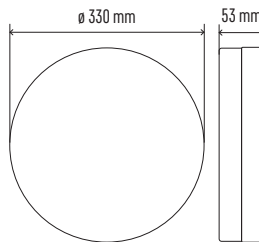

**ZM4325**

1/-/-/4

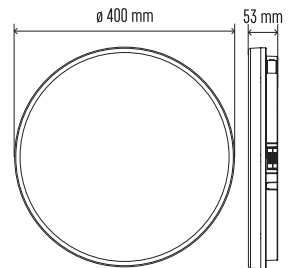

| Type   | EAN           | Power | Luminous Flux | CCT     | PF    | Flicker-Free | Diameter × D     |
|--------|---------------|-------|---------------|---------|-------|--------------|------------------|
| ZM4121 | 8592920094082 | 15 W  | 1 500 lm      | 3 000 K | > 0.9 | yes          | ∅ 220 mm × 53 mm |
| ZM4321 | 8592920094167 | 15 W  | 1 500 lm      | 4 000 K | > 0.9 | yes          | ∅ 220 mm × 53 mm |
| ZM4122 | 8592920094105 | 24 W  | 2 400 lm      | 3 000 K | > 0.9 | yes          | ∅ 330 mm × 53 mm |
| ZM4322 | 8592920094181 | 24 W  | 2 400 lm      | 4 000 K | > 0.9 | yes          | ∅ 330 mm × 53 mm |
| ZM4325 | 8592920108185 | 36 W  | 3 800 lm      | 4 000 K | > 0.9 | yes          | ∅ 400 mm × 53 mm |

**ZM4123**

1/-/-/10

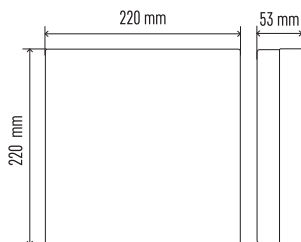

**ZM4323**

1/-/-/10

**ZM4124**

1/-/-/4

**ZM4324**

1/-/-/4

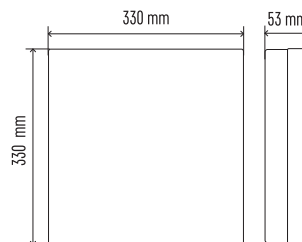

| Type   | EAN           | Power | Luminous Flux | CCT     | PF    | Flicker-Free | W × H × D         |
|--------|---------------|-------|---------------|---------|-------|--------------|-------------------|
| ZM4123 | 8592920094129 | 15 W  | 1 500 lm      | 3 000 K | > 0.9 | yes          | 220 × 220 × 53 mm |
| ZM4323 | 8592920094204 | 15 W  | 1 500 lm      | 4 000 K | > 0.9 | yes          | 220 × 220 × 53 mm |
| ZM4124 | 8592920094143 | 24 W  | 2 400 lm      | 3 000 K | > 0.9 | yes          | 330 × 330 × 53 mm |
| ZM4324 | 8592920094228 | 24 W  | 2 400 lm      | 4 000 K | > 0.9 | yes          | 330 × 330 × 53 mm |



# TORI SENSOR

TORI SENSOR luminaires are equipped with a microwave motion detection sensor with the possibility of adjusting the twilight sensor and the operating time after switching on.

**Main benefits:**

- excellent price/quality ratio
- IP44 enclosure ensures water resistance
- easy installation

**Areas of use:** lighting hallways in households, garages and technical spaces.



|                   |              |
|-------------------|--------------|
| Lifetime          | 30 000 hours |
| CRI               | > 80         |
| Body material     | plastic (PC) |
| Diffuser material | plastic (PC) |
| IP rating         | IP54         |



Photometric data available at [www.emos.eu/LDT](http://www.emos.eu/LDT)

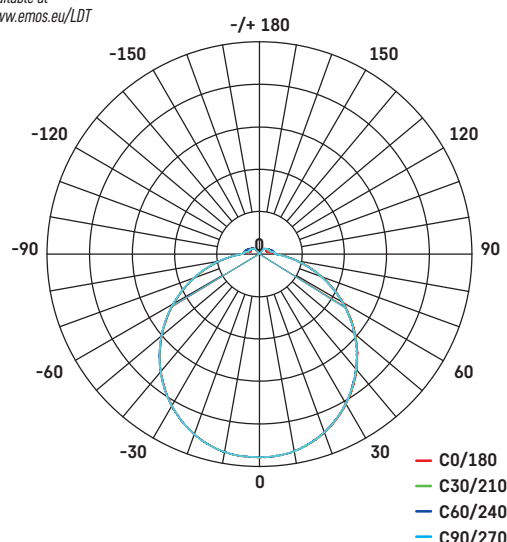

Motion sensor settings



**ZM4328**

1/-/-/10

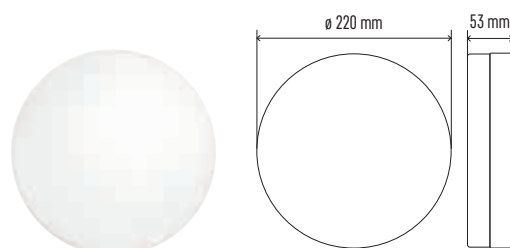

**ZM4329**

1/-/-/4

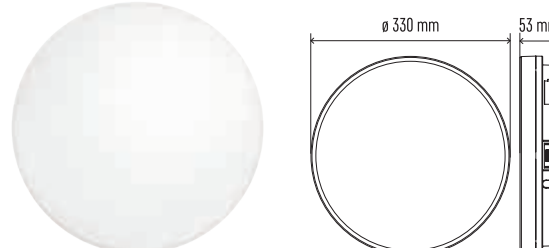

| Type   | EAN           | Power | Luminous Flux | CCT     | PF    | Detection Angle                                       | Detection Range | Time Setting   | Diameter × D     |
|--------|---------------|-------|---------------|---------|-------|---|-----------------|----------------|------------------|
| ZM4328 | 8592920108208 | 15 W  | 1 500 lm      | 4 000 K | > 0.9 | 150° – when wall-mounted, 360° – when ceiling-mounted | 10 m            | 30 s to 10 min | ø 220 mm × 53 mm |
| ZM4329 | 8592920108222 | 24 W  | 2 400 lm      | 4 000 K | > 0.9 | 150° – when wall-mounted, 360° – when ceiling-mounted | 10 m            | 30 s to 10 min | ø 330 mm × 53 mm |

# ZURI

ZURI LED luminaires are made of high quality plastic, characterised by high water resistance and allow users to freely interchange the two colours of the luminaire body.

**Main benefits:**

- 2in1 - possibility to change the colour of the luminaire body
- energy saving
- IP54 protection guarantees water resistance

**Areas of use:** all indoor and outdoor environment of residential, non-residential premises and houses.



**ZM3130**

1/-/-/6

**ZM3230**

1/-/-/6

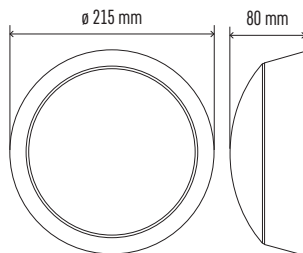

| Type   | EAN           | Power | Luminous Flux | CCT     | PF    | Diameter × D     |
|--------|---------------|-------|---------------|---------|-------|------------------|
| ZM3130 | 8592920057117 | 14 W  | 1 000 lm      | 3 000 K | > 0.5 | ø 215 mm × 80 mm |
| ZM3230 | 8592920057155 | 14 W  | 1 100 lm      | 4 000 K | > 0.5 | ø 215 mm × 80 mm |

## ZURI PIR

The ZURI PIR LED luminaires are equipped with a motion sensor that allows setting the dusk sensor and the operating time after switching on.

### Main benefits:

- 2in1 - possibility to change the colour of the luminaire body
- energy saving
- IP54 protection guarantees water resistance

**Areas of use:** all indoor and outdoor environment of residential, non-residential premises and houses.



|                   |              |
|-------------------|--------------|
| Lifetime          | 25 000 hours |
| CRI               | > 80         |
| Body material     | plastic (PC) |
| Diffuser material | plastic (PC) |
| IP rating         | IP54         |



Photometric data available at [www.emos.eu/LDT](http://www.emos.eu/LDT)

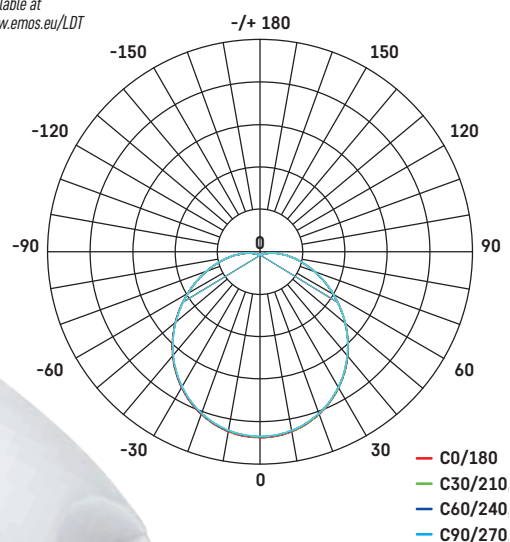

### ZM3131

1/-/-/6

### ZM3231

1/-/-/6

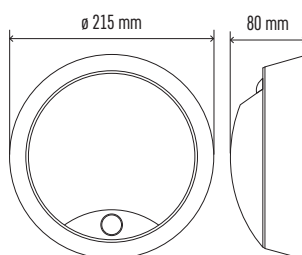

| Type   | EAN           | Power | Luminous Flux | CCT     | PF    | Detection Angle | Detection Range | Time Setting                       | Diameter × D     |
|--------|---------------|-------|---------------|---------|-------|-----------------|-----------------|------------------------------------|------------------|
| ZM3131 | 8592920057131 | 14 W  | 1 000 lm      | 3 000 K | > 0.5 | 120°            | 10 m            | min. 10 s ±5 s ~ max. 5 min ±1 min | ∅ 215 mm × 80 mm |
| ZM3231 | 8592920057179 | 14 W  | 1 100 lm      | 4 000 K | > 0.5 | 120°            | 10 m            | min. 10 s ±5 s ~ max. 5 min ±1 min | ∅ 215 mm × 80 mm |

# DORI

DORI ceiling LED luminaires are characterised by high luminous efficacy and simple design. The luminaires come in two shapes.

**Main benefits:**

- high luminous efficacy of 100 lm/W
- IP54 enclosure ensures water resistance
- easy installation

**Areas of use:** illumination of modern interiors, areas and hallways in offices, hotels and households.



|                   |              |
|-------------------|--------------|
| Lifetime          | 25 000 hours |
| CRI               | > 80         |
| Body material     | plastic (PC) |
| Diffuser material | plastic (PC) |
| IP rating         | IP54         |



Photometric data available at [www.emos.eu/LDT](http://www.emos.eu/LDT)

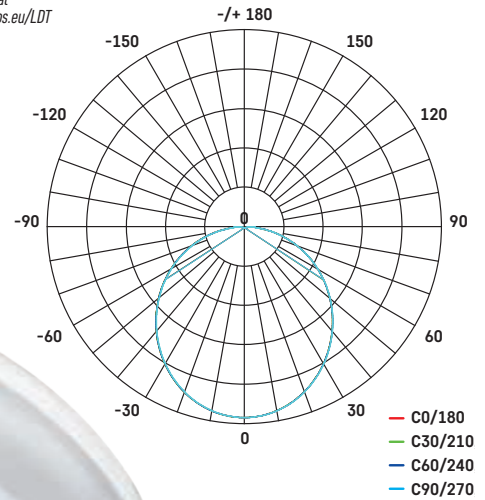

**ZM4311**

1/-/-/8

**ZM4312**

1/-/-/8

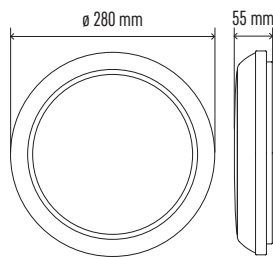

**ZM4313**

1/-/-/8

**ZM4314**

1/-/-/8

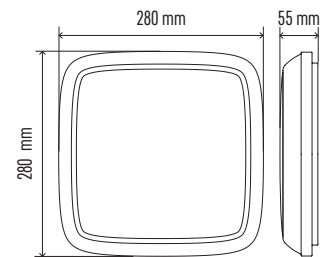

| Type   | EAN           | Power  | Luminous Flux | CCT     | PF    | Diameter × D     |
|--------|---------------|--------|---------------|---------|-------|------------------|
| ZM4311 | 8592920040546 | 18 W   | 1 800 lm      | 4 000 K | > 0.5 | ∅ 280 mm × 55 mm |
| ZM4312 | 8592920040560 | 24.5 W | 2 450 lm      | 4 000 K | > 0.5 | ∅ 280 mm × 55 mm |

| Type   | EAN           | Power  | Luminous Flux | CCT     | PF    | W × H × D         |
|--------|---------------|--------|---------------|---------|-------|-------------------|
| ZM4313 | 8592920040584 | 18 W   | 1 800 lm      | 4 000 K | > 0.5 | 280 × 280 × 55 mm |
| ZM4314 | 8592920040607 | 24.5 W | 2 450 lm      | 4 000 K | > 0.5 | 280 × 280 × 55 mm |

# QARI

QARI LED lights are made of high quality plastic and are characterised by high water resistance. The luminaires are available in several shapes.

**Main benefits:**

- circular and oval designs
- energy savings
- IP65 enclosure ensures water resistance

**Areas of use:** all indoor and outdoor environments in residential and non-residential areas and buildings.



|                   |              |
|-------------------|--------------|
| Lifetime          | 25 000 hours |
| CRI               | > 80         |
| Body material     | plastic (PC) |
| Diffuser material | plastic (PC) |
| IP rating         | IP65         |



Photometric data available at [www.emos.eu/LDT](http://www.emos.eu/LDT)

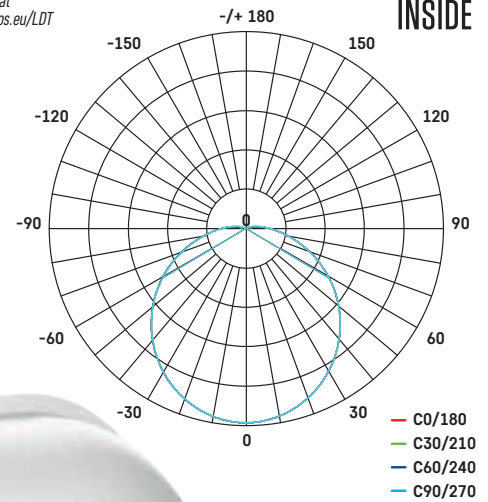

**ZM3010**

1/-/-/6

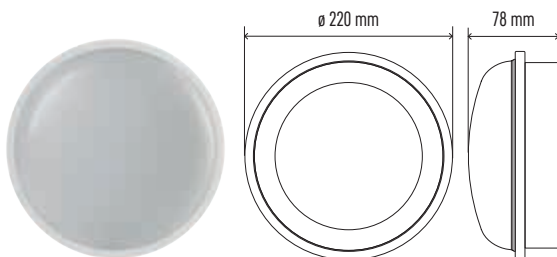

**ZM3020**

1/-/-/8

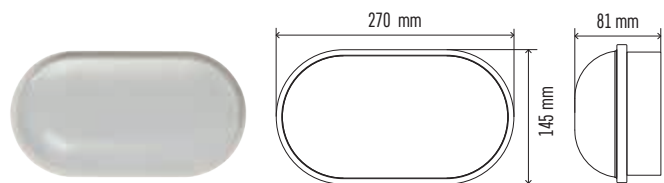

| Type   | EAN           | Power | Luminous Flux | CCT     | PF    | Flicker-Free | Diameter × D     |
|--------|---------------|-------|---------------|---------|-------|--------------|------------------|
| ZM3010 | 8592920062098 | 20 W  | 1 900 lm      | 4 000 K | > 0.5 | no           | ∅ 220 mm × 78 mm |

| Type   | EAN           | Power | Luminous Flux | CCT     | PF    | Flicker-Free | W × H × D         |
|--------|---------------|-------|---------------|---------|-------|--------------|-------------------|
| ZM3020 | 8592920062135 | 20 W  | 1 900 lm      | 4 000 K | > 0.5 | no           | 270 × 145 × 81 mm |

# FIORI

Practical LED luminaire from FIORI series is designed for ceiling or wall mounting. Although it is an economical lighting option, the excellent quality of the materials and electronics used allows us to provide an extended warranty.

**Main benefits:**

- extended warranty
- convenient price/quality ratio
- timeless design

**Areas of use:** all indoor and outdoor environments of residential, non-residential premises and houses and households.

|                   |              |
|-------------------|--------------|
| Lifetime          | 25 000 hours |
| CRI               | > 80         |
| Body material     | plastic (PP) |
| Diffuser material | plastic (PS) |
| IP rating         | IP20         |



Photometric data available at [www.emos.eu/LDT](http://www.emos.eu/LDT)

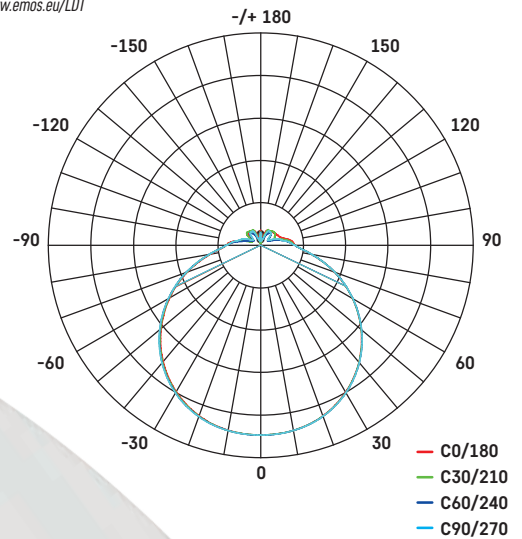

**ZM1114**

5/-/-/5

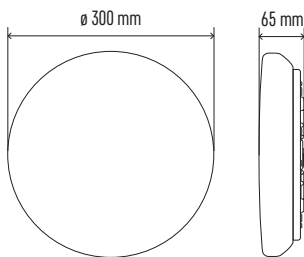

| Type   | EAN           | Power | Luminous Flux | CCT     | PF    | Diameter × D     |
|--------|---------------|-------|---------------|---------|-------|------------------|
| ZM1114 | 8592920090299 | 14 W  | 1 200 lm      | 4 000 K | > 0.5 | ø 300 mm × 65 mm |



# RUBIC

The practical RUBIC LED luminaires in white are made of high-quality plastic and designed for surface mounting. The materials used ensure a long service life with minimal loss of luminosity.

**Main benefits:**

- 2in1 - built-in and mounted installation thanks to mounting frame
- high luminous efficiency
- conservative design
- integrated driver

**Areas of use:** indoor lighting in households.



**ZM5432**

1/-/-/36

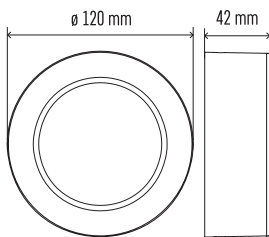

**ZM5442**

1/-/-/24

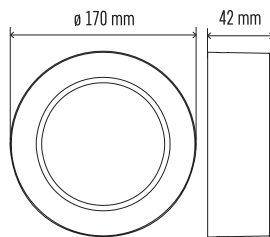

**ZM5452**

1/-/-/12

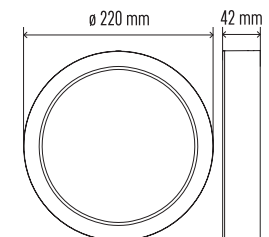

| Type   | EAN           | Power | Luminous Flux | CCT     | PF    | Diameter × D     |
|--------|---------------|-------|---------------|---------|-------|------------------|
| ZM5432 | 8592920108505 | 9 W   | 900 lm        | 4 000 K | > 0.5 | ø 120 mm × 42 mm |
| ZM5442 | 8592920108468 | 18 W  | 1 800 lm      | 4 000 K | > 0.7 | ø 170 mm × 42 mm |
| ZM5452 | 8592920108413 | 24 W  | 2 400 lm      | 4 000 K | > 0.7 | ø 220 mm × 42 mm |





|                   |              |
|-------------------|--------------|
| Lifetime          | 25 000 hours |
| CRI               | > 80         |
| Body material     | plastic (PC) |
| Diffuser material | plastic (PC) |
| IP rating         | IP20         |



Photometric data available at [www.emos.eu/LDT](http://www.emos.eu/LDT)

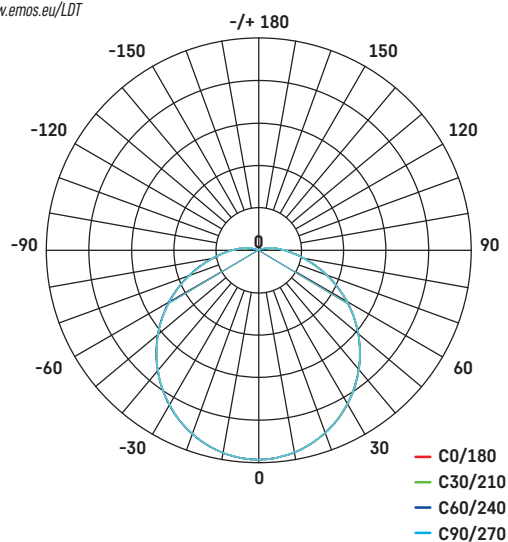

## ZM6432

1/-/-/36

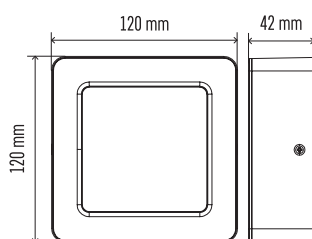

## ZM6442

1/-/-/24

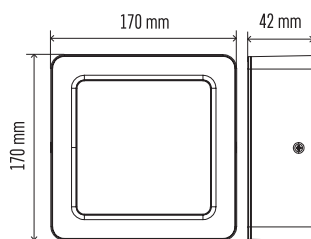

## ZM6452

1/-/-/12

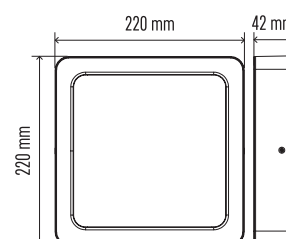

| Type   | EAN           | Power | Luminous Flux | CCT     | PF    | W × H × D         |
|--------|---------------|-------|---------------|---------|-------|-------------------|
| ZM6432 | 8592920108369 | 9 W   | 900 lm        | 4 000 K | > 0.5 | 120 × 120 × 42 mm |
| ZM6442 | 8592920108338 | 18 W  | 1 800 lm      | 4 000 K | > 0.7 | 170 × 170 × 42 mm |
| ZM6452 | 8592920108307 | 24 W  | 2 400 lm      | 4 000 K | > 0.7 | 220 × 220 × 42 mm |

# Room Luminaires

## RECESSED LUMINAIRES

### SIMMI

**EXCLUSIVE**

ZD3121      ZD3122      ZD3221      ZD3222

..... see page 90–91

### VIXXO

**PROFI**

ZV1112      ZV1122      ZV1132      ZV1142      ZV1152

..... see page 92

ZV2112      ZV2122      ZV2132      ZV2142      ZV2152

..... see page 93

### NEXXO

**PROFI**

ZD1124    ZD1125      ZD1134    ZD1135      ZD1144    ZD1145      ZD1154    ZD1155

..... see page 94–95

ZD2124    ZD2125      ZD2134    ZD2135      ZD2144    ZD2145      ZD2154    ZD2155

..... see page 96–97

## NEXXO

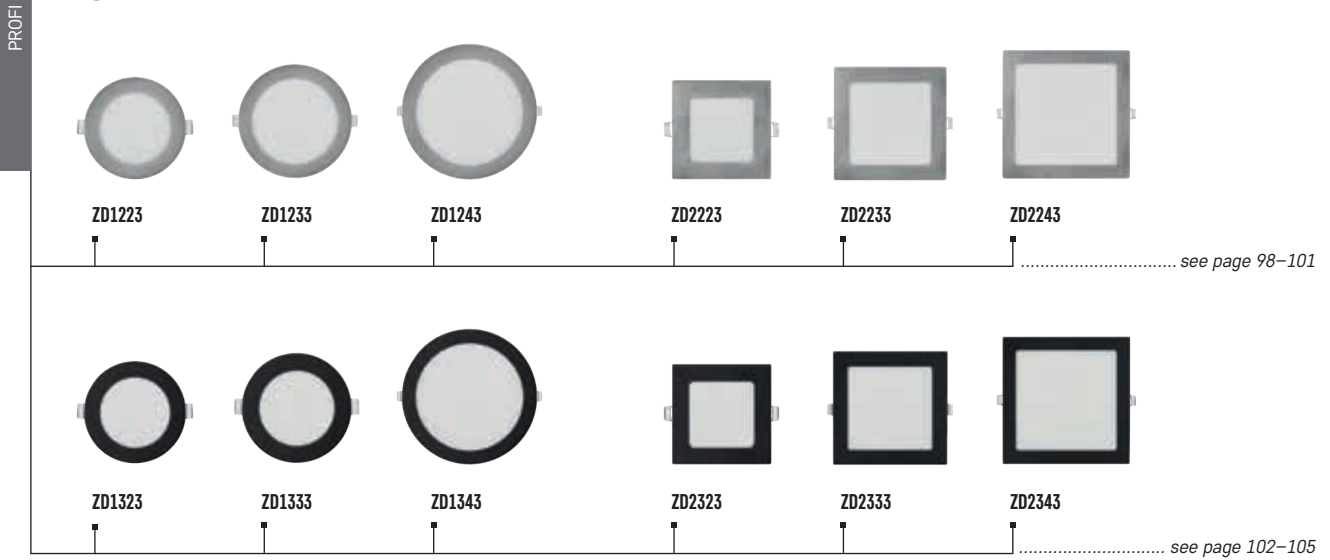

## EXTENSIO



## RUBIC

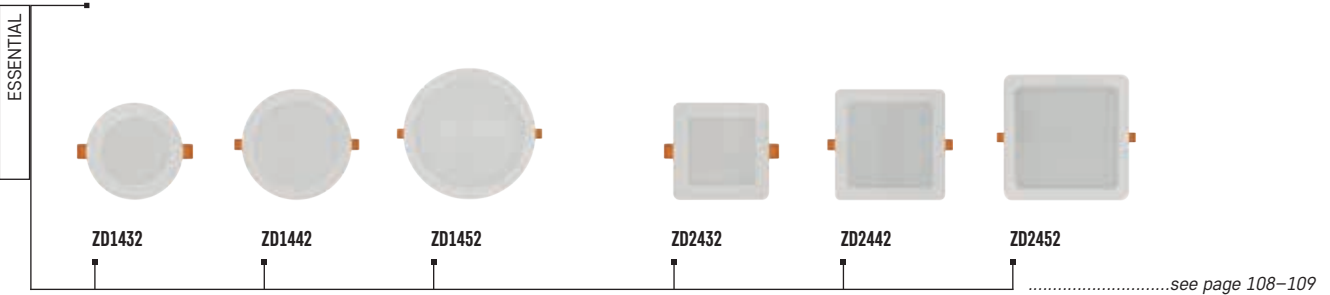

# SIMMI

Elegant LED spotlights EXCLUSIVE are fitted with an integrated driver and serve as a replacement for classic spotlights. Available in white or with a brushed nickel surface finish.

### Main benefits:

- top-quality and exclusive appearance
- integrated driver
- tiltable

**Areas of use:** illumination of modern interiors, areas and hallways in offices, hotels and households.

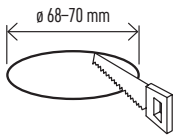

### ZD3121

1/-/6/60



### ZD3122

1/-/6/60

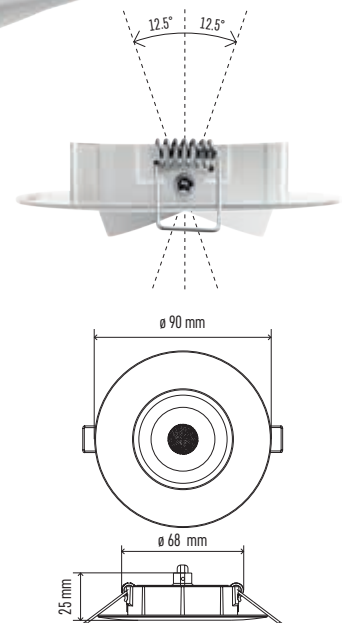

| Type   | EAN           | Power | Luminous Flux | CCT     | PF    | Beam Angle | Diameter × D    |
|--------|---------------|-------|---------------|---------|-------|------------|-----------------|
| ZD3121 | 8592920054482 | 5 W   | 450 lm        | 3 000 K | > 0.5 | 100°       | ø 90 mm × 25 mm |
| ZD3122 | 8592920054512 | 5 W   | 450 lm        | 4 000 K | > 0.5 | 100°       | ø 90 mm × 25 mm |

|                   |                     |
|-------------------|---------------------|
| Lifetime          | 25 000 hours        |
| CRI               | > 80                |
| Body material     | plastic + aluminium |
| Diffuser material | plastic (PC)        |
| IP rating         | IP20                |



Photometric data available at [www.emos.eu/LDT](http://www.emos.eu/LDT)

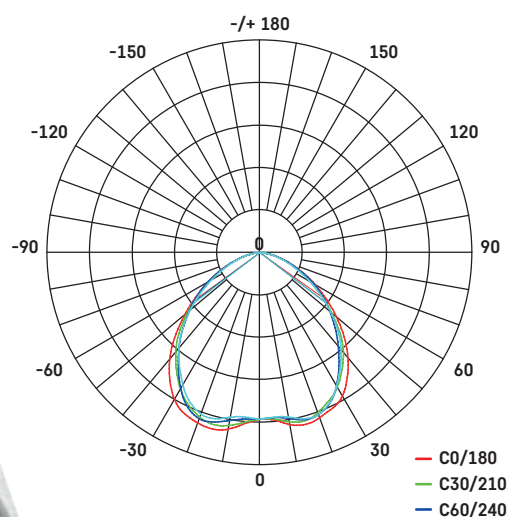

## ZD3221

1/-/6/60

## ZD3222

1/-/6/60

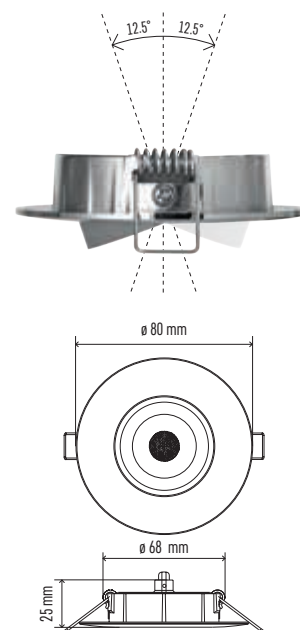

| Type   | EAN           | Power | Luminous Flux | CCT     | PF    | Beam Angle | Diameter × D    |
|--------|---------------|-------|---------------|---------|-------|------------|-----------------|
| ZD3221 | 8592920054543 | 5 W   | 450 lm        | 3 000 K | > 0.5 | 100°       | ø 80 mm × 25 mm |
| ZD3222 | 8592920054574 | 5 W   | 450 lm        | 4 000 K | > 0.5 | 100°       | ø 80 mm × 25 mm |

# VIXXO

The attractive frameless VIXXO LED luminaires are made of high-quality aluminium alloy with a white outer finish in combination with a diffuser made of milky durable plastic. The luminaires have increased water resistance and allow horizontal and vertical installation.

## Main benefits:

- attractive slim design
- IP65 enclosure ensures water resistance
- easy to install

**Areas of use:** indoor and outdoor use, suitable particularly for kitchens, bathrooms and toilets.

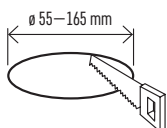

**ZV1112**

☐ 1/-/4/20



**ZV1122**

☐ 1/-/4/20



**ZV1132**

☐ 1/-/4/16



**ZV1142**

☐ 1/-/-/10



**ZV1152**

☐ 1/-/-/12

## White colour

| Type    | EAN           | Power  | Luminous Flux | CCT     | PF    | Flicker-Free | Diameter × D     |
|---------|---------------|--------|---------------|---------|-------|--------------|------------------|
| ZV1112  | 8592920067888 | 6 W    | 500 lm        | 4 000 K | > 0.5 | no           | ø 75 mm × 20 mm  |
| ZV1122  | 8592920067901 | 7.5 W  | 650 lm        | 4 000 K | > 0.9 | no           | ø 100 mm × 20 mm |
| ZV1132  | 8592920067949 | 10 W   | 900 lm        | 4 000 K | > 0.9 | no           | ø 125 mm × 20 mm |
| ZV1142  | 8592920067963 | 13.5 W | 1 250 lm      | 4 000 K | > 0.9 | no           | ø 155 mm × 20 mm |
| ZV1152  | 8592920067987 | 19 W   | 1 700 lm      | 4 000 K | > 0.9 | no           | ø 185 mm × 20 mm |
| ZV1142T | 8592920115732 | 13.5 W | 1 250 lm      | 4 000 K | > 0.9 | no           | ø 155 mm × 20 mm |
| ZV1152T | 8592920115749 | 19 W   | 1 700 lm      | 4 000 K | > 0.9 | no           | ø 185 mm × 20 mm |

## Set with additional dimmable driver

| Type    | Panel    | Dimmable power supply |
|---------|----------|-----------------------|
| ZV1142T | = ZV1142 | + ZZ1435T             |
| ZV1152T | = ZV1152 | + ZZ2055T             |



See page 134



|                   |              |
|-------------------|--------------|
| Lifetime          | 30 000 hours |
| CRI               | > 80         |
| Body material     | aluminium    |
| Diffuser material | plastic (PC) |
| LGP material      | PMMA         |
| IP rating         | IP65         |



Photometric data available at [www.emos.eu/LDT](http://www.emos.eu/LDT)

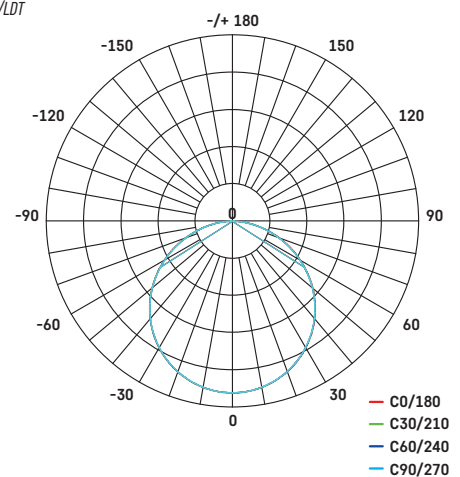

**ZV2112**

1/-/4/20

**ZV2122**

1/-/4/20

**ZV2132**

1/-/4/16

**ZV2142**

1/-/-/10

**ZV2152**

1/-/-/12

### White colour

| Type    | EAN           | Power  | Luminous Flux | CCT     | PF    | Flicker-Free | W × H × D         |
|---------|---------------|--------|---------------|---------|-------|--------------|-------------------|
| ZV2112  | 8592920068021 | 6 W    | 500 lm        | 4 000 K | > 0.5 | no           | 75 × 75 × 20 mm   |
| ZV2122  | 8592920068045 | 7.5 W  | 650 lm        | 4 000 K | > 0.9 | no           | 100 × 100 × 20 mm |
| ZV2132  | 8592920068083 | 10 W   | 900 lm        | 4 000 K | > 0.9 | no           | 125 × 125 × 20 mm |
| ZV2142  | 8592920068106 | 13.5 W | 1 250 lm      | 4 000 K | > 0.9 | no           | 155 × 155 × 20 mm |
| ZV2152  | 8592920068120 | 19 W   | 1 700 lm      | 4 000 K | > 0.9 | no           | 185 × 185 × 20 mm |
| ZV2142T | 8592920115756 | 13.5 W | 1 250 lm      | 4 000 K | > 0.9 | no           | 155 × 155 × 20 mm |
| ZV2152T | 8592920115763 | 19 W   | 1 700 lm      | 4 000 K | > 0.9 | no           | 185 × 185 × 20 mm |

### Set with additional dimmable driver

| Type    | Panel    | Dimmable power supply |
|---------|----------|-----------------------|
| ZV2142T | = ZV2142 | + ZZ1435T             |
| ZV2152T | = ZV2152 | + ZZ2055T             |



See page 134

# NEXXO

Practical NEXXO circular LED luminaires in white are made of cast aluminium and acrylic glass. The luminaires are designed to be recessed into plasterboard and, with regard to the materials used, their long service life is ensured with a minimum loss of luminosity.

## Main benefits:

- high-quality LIFUD drivers
- LGP – PMMA – pleasant light distribution
- easy installation

**Areas of use:** lighting modern interiors in households, offices or hotels.

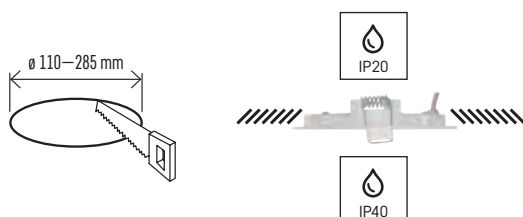

**ZD1124** **ZD1125**

1/-/-/8 1/-/-/8



**ZD1134** **ZD1135**

1/-/-/8 1/-/-/8



**ZD1144** **ZD1145**

1/-/-/8 1/-/-/8



**ZD1154** **ZD1155**

1/-/-/4 1/-/-/4

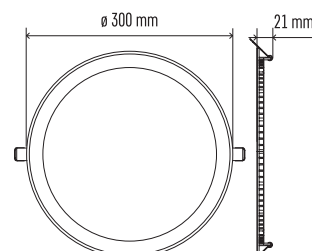
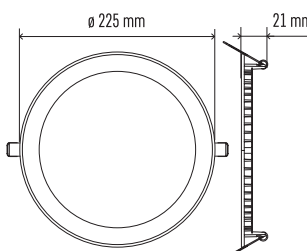
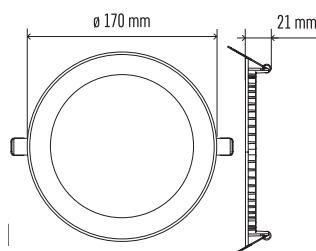
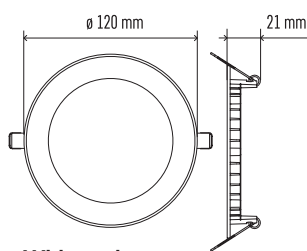

White colour

| Type           | EAN           | Power  | Luminous Flux | CCT     | PF    | Flicker-Free | Diameter × D  |
|----------------|---------------|--------|---------------|---------|-------|--------------|---------------|
| <b>ZD1124</b>  | 8592920108260 | 7 W    | 450 lm        | 3 000 K | > 0.5 | yes          | ø 120 × 21 mm |
| <b>ZD1125</b>  | 8592920108284 | 7 W    | 480 lm        | 4 000 K | > 0.5 | yes          | ø 120 × 21 mm |
| <b>ZD1134</b>  | 8592920108321 | 12.5 W | 1 000 lm      | 3 000 K | > 0.5 | yes          | ø 170 × 21 mm |
| <b>ZD1135</b>  | 8592920108376 | 12.5 W | 1 050 lm      | 4 000 K | > 0.5 | yes          | ø 170 × 21 mm |
| <b>ZD1144</b>  | 8592920108406 | 18 W   | 1 500 lm      | 3 000 K | > 0.9 | yes          | ø 225 × 21 mm |
| <b>ZD1145</b>  | 8592920108444 | 18 W   | 1 600 lm      | 4 000 K | > 0.9 | yes          | ø 225 × 21 mm |
| <b>ZD1154</b>  | 8592920108482 | 25 W   | 2 000 lm      | 3 000 K | > 0.9 | yes          | ø 300 × 21 mm |
| <b>ZD1155</b>  | 8592920108529 | 25 W   | 2 100 lm      | 4 000 K | > 0.9 | yes          | ø 300 × 21 mm |
| <b>ZD1134T</b> | 8592920114117 | 12.5 W | 1 000 lm      | 3 000 K | > 0.5 | yes          | ø 170 × 21 mm |
| <b>ZD1135T</b> | 8592920114124 | 12.5 W | 1 050 lm      | 4 000 K | > 0.5 | yes          | ø 170 × 21 mm |
| <b>ZD1144T</b> | 8592920114131 | 18 W   | 1 500 lm      | 3 000 K | > 0.9 | yes          | ø 225 × 21 mm |
| <b>ZD1145T</b> | 8592920114148 | 18 W   | 1 600 lm      | 4 000 K | > 0.9 | yes          | ø 225 × 21 mm |
| <b>ZD1154T</b> | 8592920114155 | 25 W   | 2 000 lm      | 3 000 K | > 0.9 | yes          | ø 300 × 21 mm |
| <b>ZD1155T</b> | 8592920114162 | 25 W   | 2 100 lm      | 4 000 K | > 0.9 | yes          | ø 300 × 21 mm |





Mounting pin for flush mounting

|                   |                |
|-------------------|----------------|
| Lifetime          | 30 000 hours   |
| CRI               | > 80           |
| Body material     | aluminium      |
| Diffuser material | plastic (PMMA) |
| LGP material      | PMMA           |
| IP rating         | IP40/IP20      |



Photometric data available at [www.emos.eu/LDT](http://www.emos.eu/LDT)

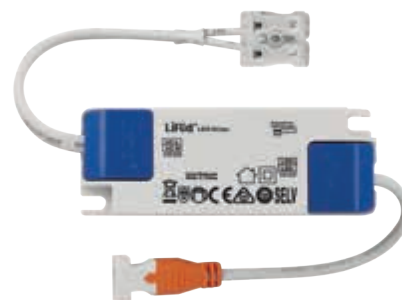
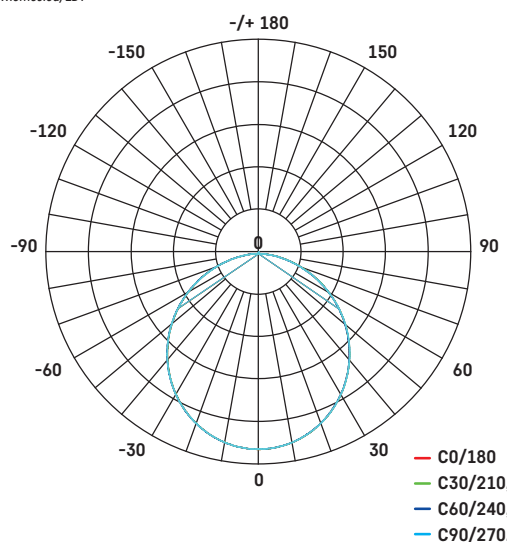

### Set with additional dimmable driver

| Type    | Panel    | Dimmable power supply |
|---------|----------|-----------------------|
| ZD1134T | = ZD1134 | + ZZ1435T             |
| ZD1135T | = ZD1135 | + ZZ1435T             |
| ZD1144T | = ZD1144 | + ZZ2055T             |
| ZD1145T | = ZD1134 | + ZZ2055T             |
| ZD1154T | = ZD1135 | + ZZ3070T             |
| ZD1155T | = ZD1144 | + ZZ3070T             |

See page 134

Connection of a dimmable driver



# NEXXO

Practical NEXXO square LED luminaires in white are made of cast aluminium and acrylic glass. The luminaires are designed to be recessed into plasterboard and, with regard to the materials used, their long service life is ensured with a minimum loss of luminosity.

## Main benefits:

- high-quality LIFUD drivers
- LGP – PMMA – pleasant light distribution
- easy installation

**Areas of use:** lighting modern interiors in households, offices or hotels.

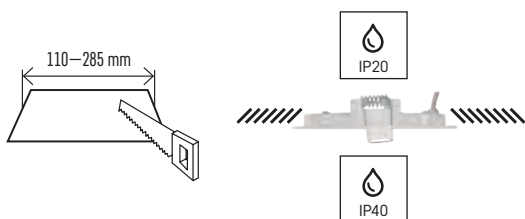
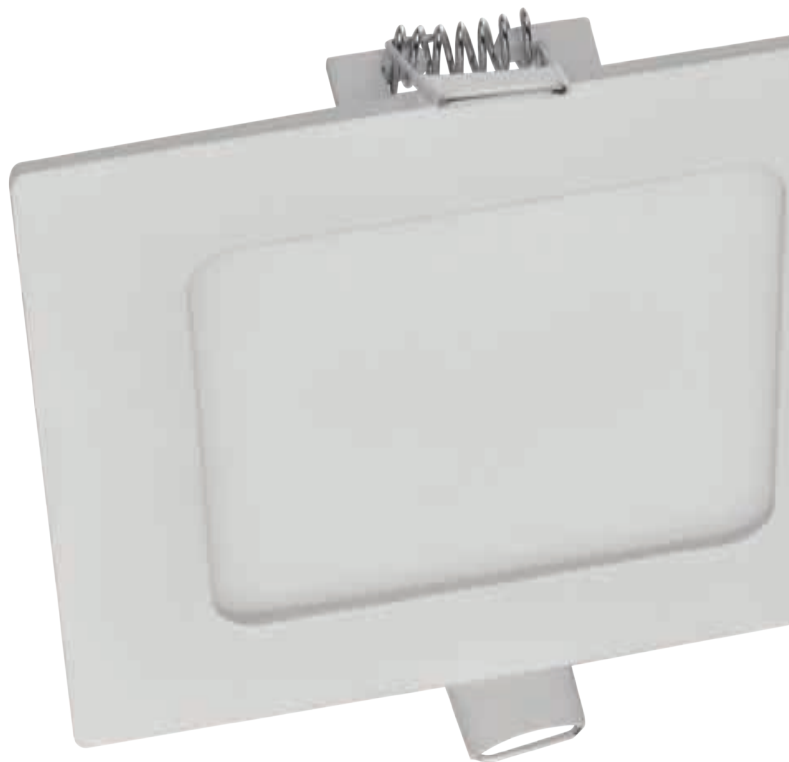
**ZD2124**

1/-/-/8

**ZD2125**

1/-/-/8

**ZD2134**

1/-/-/8

**ZD2135**

1/-/-/8

**ZD2144**

1/-/-/8

**ZD2145**

1/-/-/8

**ZD2154**

1/-/-/4

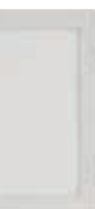
**ZD2155**

1/-/-/4

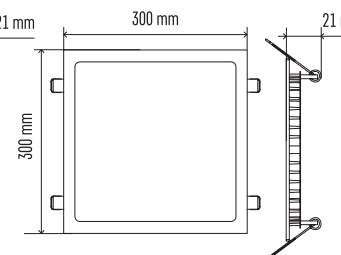
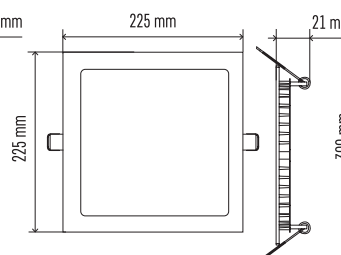
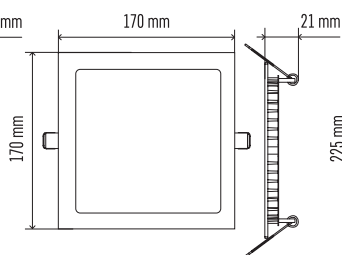
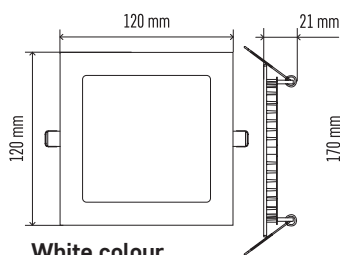
**White colour**

| Type           | EAN           | Power  | Luminous Flux | CCT     | PF    | Flicker-Free | W × H × D         |
|----------------|---------------|--------|---------------|---------|-------|--------------|-------------------|
| <b>ZD2124</b>  | 8592920108741 | 7 W    | 450 lm        | 3 000 K | > 0.5 | yes          | 120 × 120 × 21 mm |
| <b>ZD2125</b>  | 8592920108772 | 7 W    | 480 lm        | 4 000 K | > 0.5 | yes          | 120 × 120 × 21 mm |
| <b>ZD2134</b>  | 8592920108802 | 12.5 W | 1 000 lm      | 3 000 K | > 0.5 | yes          | 170 × 170 × 21 mm |
| <b>ZD2135</b>  | 8592920108840 | 12.5 W | 1 050 lm      | 4 000 K | > 0.5 | yes          | 170 × 170 × 21 mm |
| <b>ZD2144</b>  | 8592920108871 | 18 W   | 1 500 lm      | 3 000 K | > 0.9 | yes          | 225 × 225 × 21 mm |
| <b>ZD2145</b>  | 8592920108918 | 18 W   | 1 600 lm      | 4 000 K | > 0.9 | yes          | 225 × 225 × 21 mm |
| <b>ZD2154</b>  | 8592920108956 | 25 W   | 2 000 lm      | 3 000 K | > 0.9 | yes          | 300 × 300 × 21 mm |
| <b>ZD2155</b>  | 8592920108994 | 25 W   | 2 100 lm      | 4 000 K | > 0.9 | yes          | 300 × 300 × 21 mm |
| <b>ZD2134T</b> | 8592920114179 | 12.5 W | 1 000 lm      | 3 000 K | > 0.5 | yes          | 170 × 170 × 21 mm |
| <b>ZD2135T</b> | 8592920114186 | 12.5 W | 1 050 lm      | 4 000 K | > 0.5 | yes          | 170 × 170 × 21 mm |
| <b>ZD2144T</b> | 8592920114193 | 18 W   | 1 500 lm      | 3 000 K | > 0.9 | yes          | 225 × 225 × 21 mm |
| <b>ZD2145T</b> | 8592920114209 | 18 W   | 1 600 lm      | 4 000 K | > 0.9 | yes          | 225 × 225 × 21 mm |
| <b>ZD2154T</b> | 8592920114216 | 25 W   | 2 000 lm      | 3 000 K | > 0.9 | yes          | 300 × 300 × 21 mm |
| <b>ZD2155T</b> | 8592920114223 | 25 W   | 2 100 lm      | 4 000 K | > 0.9 | yes          | 300 × 300 × 21 mm |



Mounting pin for flush mounting

|                   |                |
|-------------------|----------------|
| Lifetime          | 30 000 hours   |
| CRI               | > 80           |
| Body material     | aluminium      |
| Diffuser material | plastic (PMMA) |
| LGP material      | PMMA           |
| IP rating         | IP40/IP20      |



Photometric data available at [www.emos.eu/LDT](http://www.emos.eu/LDT)

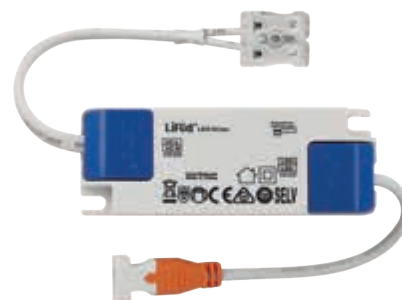
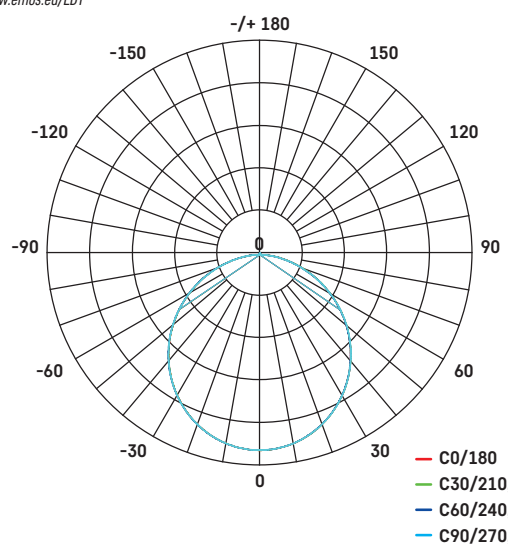

### Set with additional dimmable driver

| Type    | Panel      | Dimmable power supply |
|---------|------------|-----------------------|
| ZD2134T | = ZD2134 + | ZZ1435T               |
| ZD2135T | = ZD2135 + | ZZ1435T               |
| ZD2144T | = ZD2144 + | ZZ2055T               |
| ZD2145T | = ZD2145 + | ZZ2055T               |
| ZD2154T | = ZD2154 + | ZZ3070T               |
| ZD2155T | = ZD2155 + | ZZ3070T               |

See page 134

Connection of a dimmable driver



# NEXXO

Practical NEXXO LED luminaires in brushed nickel are made of cast aluminium and acrylic glass, designed to be recessed into plasterboard. The materials used ensure a long service life with minimal loss of luminosity.

## Main benefits:

- the possibility of selecting the light temperature during installation
- high-quality LIFUD drivers
- LGP – PMMA – pleasant light distribution
- easy installation due to easy-installation bracket

**Areas of use:** lighting modern interiors in households, offices or hotels.

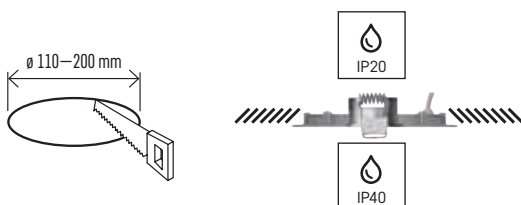

### ZD1223

1/-/-/8

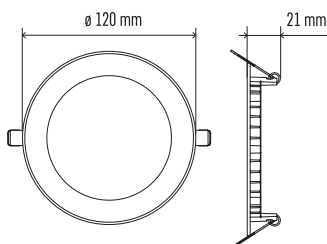

### ZD1233

1/-/-/8

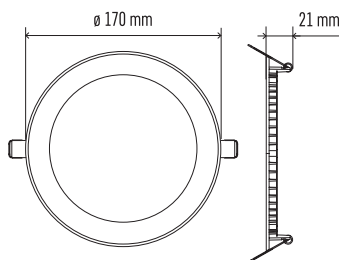

### ZD1243

1/-/-/8

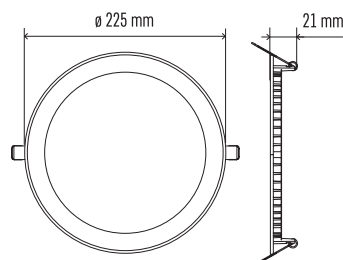

Silver color

| Type    | EAN           | Power  | Luminous Flux | CCT                 | PF    | Flicker-Free | Diameter × D  |
|---------|---------------|--------|---------------|---------------------|-------|--------------|---------------|
| ZD1223  | 8592920108543 | 7 W    | 480 lm        | 3 000/3 500/4 000 K | > 0.5 | yes          | ø 120 × 21 mm |
| ZD1233  | 8592920108581 | 12.5 W | 1 050 lm      | 3 000/3 500/4 000 K | > 0.5 | yes          | ø 170 × 21 mm |
| ZD1243  | 8592920108611 | 18 W   | 1 600 lm      | 3 000/3 500/4 000 K | > 0.9 | yes          | ø 225 × 21 mm |
| ZD1233T | 8592920114230 | 12.5 W | 1 050 lm      | 3 000/3 500/4 000 K | > 0.5 | yes          | ø 170 × 21 mm |
| ZD1243T | 8592920114247 | 18 W   | 1 600 lm      | 3 000/3 500/4 000 K | > 0.9 | yes          | ø 225 × 21 mm |



Mounting pin for flush mounting

|                   |                |
|-------------------|----------------|
| Lifetime          | 30 000 hours   |
| CRI               | > 80           |
| Body material     | aluminium      |
| Diffuser material | plastic (PMMA) |
| LGP material      | PMMA           |
| IP rating         | IP40/IP20      |



Photometric data available at [www.emos.eu/LDT](http://www.emos.eu/LDT)

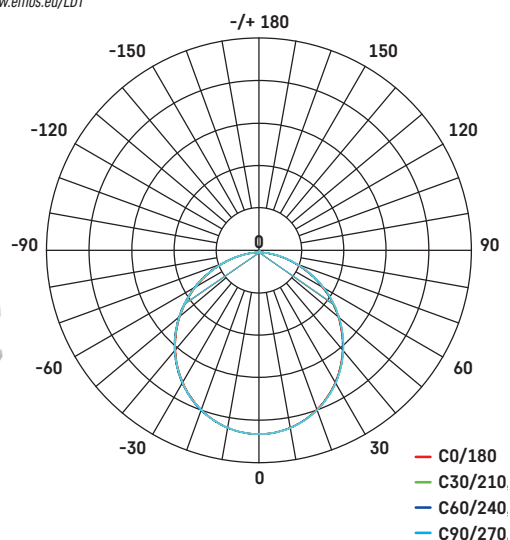

- 3 000 K
- 3 500 K
- 4 000 K



Adjustable during installation

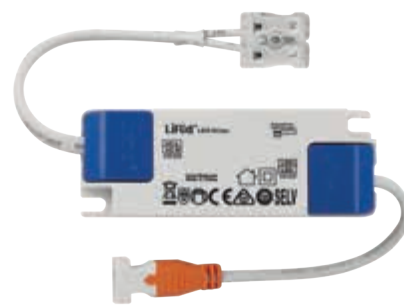

**Set with additional dimmable driver**

| Type    | Panel    | + | Dimmable power supply |
|---------|----------|---|-----------------------|
| ZD1233T | = ZD1233 | + | ZZ1435T               |
| ZD1243T | = ZD1243 | + | ZZ2055T               |

See page 134



3 000 K



3 500 K



4 000 K

# NEXXO

Practical NEXXO LED luminaires in brushed nickel are made of cast aluminium and acrylic glass, designed to be recessed into plasterboard. The materials used ensure a long service life with minimal loss of luminosity.

## Main benefits:

- the possibility of selecting the light temperature during installation
- high-quality LIFUD drivers
- LGP – PMMA – pleasant light distribution
- easy installation due to easy-installation bracket

**Areas of use:** lighting modern interiors in households, offices or hotels.

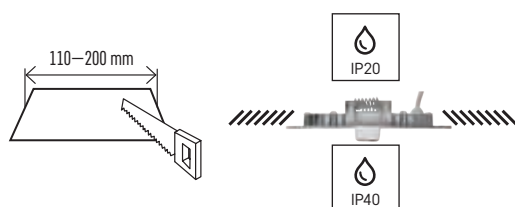

### ZD2223

1/-/-/8  
120 mm

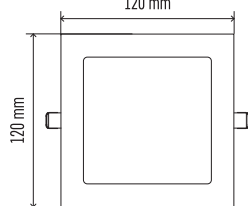

### ZD2233

1/-/-/8  
170 mm

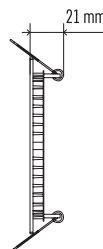
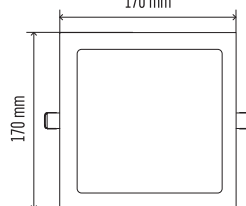

### ZD2243

1/-/-/8  
225 mm

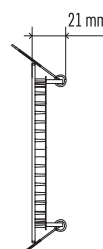
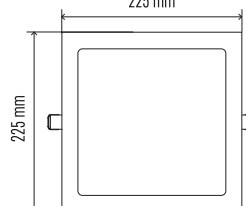

## Silver color

| Type    | EAN           | Power  | Luminous Flux | CCT                 | PF    | Flicker-Free | W × H × D         |
|---------|---------------|--------|---------------|---------------------|-------|--------------|-------------------|
| ZD2223  | 8592920109021 | 7 W    | 480 lm        | 3 000/3 500/4 000 K | > 0.5 | yes          | 120 × 120 × 21 mm |
| ZD2233  | 8592920109052 | 12.5 W | 1 050 lm      | 3 000/3 500/4 000 K | > 0.5 | yes          | 175 × 175 × 21 mm |
| ZD2243  | 8592920109083 | 18 W   | 1 600 lm      | 3 000/3 500/4 000 K | > 0.9 | yes          | 225 × 225 × 21 mm |
| ZD2233T | 8592920114254 | 12.5 W | 1 050 lm      | 3 000/3 500/4 000 K | > 0.5 | yes          | 175 × 175 × 21 mm |
| ZD2243T | 8592920114261 | 18 W   | 1 600 lm      | 3 000/3 500/4 000 K | > 0.9 | yes          | 225 × 225 × 21 mm |

|                   |                |
|-------------------|----------------|
| Lifetime          | 30 000 hours   |
| CRI               | > 80           |
| Body material     | aluminium      |
| Diffuser material | plastic (PMMA) |
| LGP material      | PMMA           |
| IP rating         | IP40/IP20      |

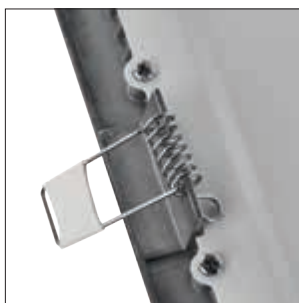

Mounting pin for flush mounting



Photometric data available at [www.emos.eu/LDT](http://www.emos.eu/LDT)

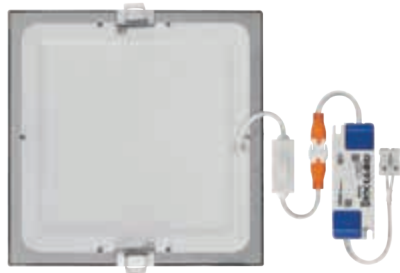
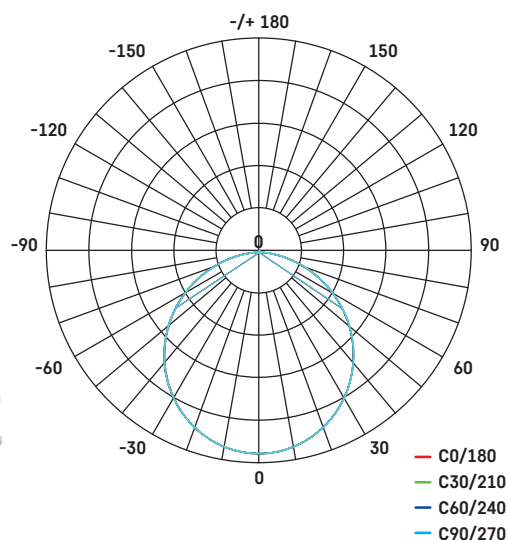

3 000 K  
3 500 K  
4 000 K



Adjustable during installation



**Set with additional dimmable driver**

| Type    | Panel    | + | Dimmable power supply |
|---------|----------|---|-----------------------|
| ZD1233T | = ZD1233 | + | ZZ1435T               |
| ZD1243T | = ZD1243 | + | ZZ2055T               |

See page 134



3 000 K



3 500 K



4 000 K

# NEXXO

Practical NEXXO LED luminaires in black are made of cast aluminium and acrylic glass, designed to be recessed into plasterboard. The materials used ensure a long service life with minimal loss of luminosity.

## Main benefits:

- the possibility of selecting the light temperature during installation
- high-quality LIFUD drivers
- LGP – PMMA – pleasant light distribution
- easy installation due to easy-installation bracket

**Areas of use:** lighting modern interiors in households, offices or hotels.

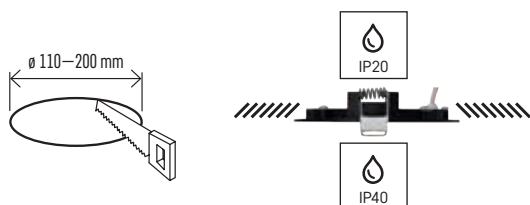

### ZD1323

1/-/-/8

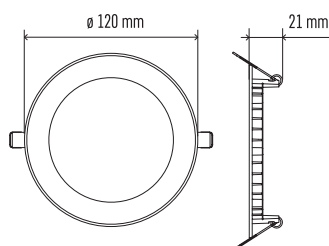

### ZD1333

1/-/-/8

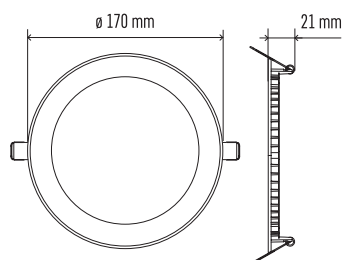

### ZD1343

1/-/-/8

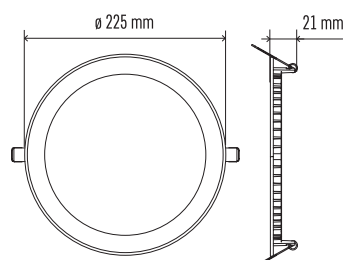

## Black color

| Type    | EAN           | Power  | Luminous Flux | CCT                 | PF    | Flicker-Free | Diameter × D  |
|---------|---------------|--------|---------------|---------------------|-------|--------------|---------------|
| ZD1323  | 8592920108659 | 7 W    | 480 lm        | 3 000/3 500/4 000 K | > 0.5 | yes          | ø 120 × 21 mm |
| ZD1333  | 8592920108680 | 12.5 W | 1 050 lm      | 3 000/3 500/4 000 K | > 0.5 | yes          | ø 170 × 21 mm |
| ZD1343  | 8592920108710 | 18 W   | 1 600 lm      | 3 000/3 500/4 000 K | > 0.9 | yes          | ø 225 × 21 mm |
| ZD1333T | 8592920114278 | 12.5 W | 1 050 lm      | 3 000/3 500/4 000 K | > 0.5 | yes          | ø 170 × 21 mm |
| ZD1343T | 8592920114285 | 18 W   | 1 600 lm      | 3 000/3 500/4 000 K | > 0.9 | yes          | ø 225 × 21 mm |





Mounting pin for flush mounting

|                   |                |
|-------------------|----------------|
| Lifetime          | 30 000 hours   |
| CRI               | > 80           |
| Body material     | aluminium      |
| Diffuser material | plastic (PMMA) |
| LGP material      | PMMA           |
| IP rating         | IP40/IP20      |



Photometric data available at [www.emos.eu/LDT](http://www.emos.eu/LDT)

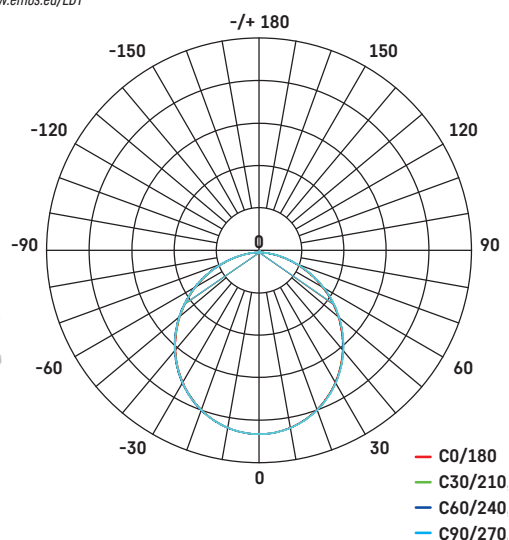

- 3 000 K
- 3 500 K
- 4 000 K



Adjustable during installation



**Set with additional dimmable driver**

| Type    | Panel    | + | Dimmable power supply |
|---------|----------|---|-----------------------|
| ZD1333T | = ZD1333 | + | ZZ1435T               |
| ZD1343T | = ZD1343 | + | ZZ2055T               |

See page 134



3 000 K



3 500 K



4 000 K

# NEXXO

Practical NEXXO LED luminaires in black are made of cast aluminium and acrylic glass, designed to be recessed into plasterboard. The materials used ensure a long service life with minimal loss of luminosity.

## Main benefits:

- the possibility of selecting the light temperature during installation
- high-quality LIFUD drivers
- LGP – PMMA – pleasant light distribution
- easy installation due to easy-installation bracket

**Areas of use:** lighting modern interiors in households, offices or hotels.

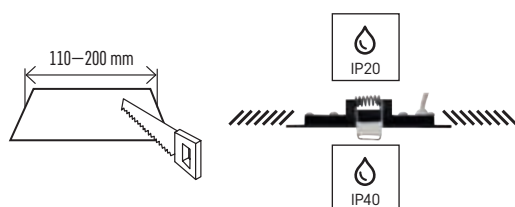

### ZD2323

1/-/-/8

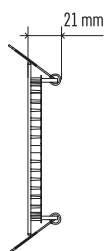
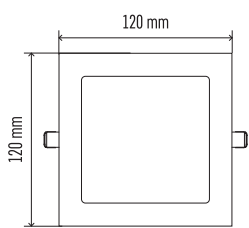

### ZD2333

1/-/-/8

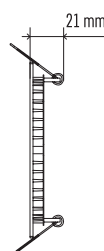
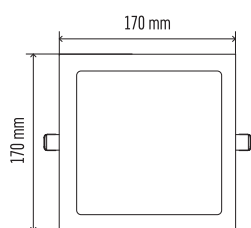

### ZD2343

1/-/-/8

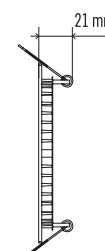
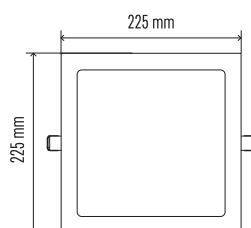

## Black color

| Type    | EAN           | Power  | Luminous Flux | CCT                 | PF    | Flicker-Free | W × H × D         |
|---------|---------------|--------|---------------|---------------------|-------|--------------|-------------------|
| ZD2323  | 8592920109120 | 7 W    | 480 lm        | 3 000/3 500/4 000 K | > 0.5 | yes          | 120 × 120 × 21 mm |
| ZD2333  | 8592920109151 | 12.5 W | 1 050 lm      | 3 000/3 500/4 000 K | > 0.5 | yes          | 170 × 170 × 21 mm |
| ZD2343  | 8592920109182 | 18 W   | 1 600 lm      | 3 000/3 500/4 000 K | > 0.9 | yes          | 225 × 225 × 21 mm |
| ZD2333T | 8592920114292 | 12.5 W | 1 050 lm      | 3 000/3 500/4 000 K | > 0.5 | yes          | 170 × 170 × 21 mm |
| ZD2343T | 8592920114308 | 18 W   | 1 600 lm      | 3 000/3 500/4 000 K | > 0.9 | yes          | 225 × 225 × 21 mm |

|                   |                |
|-------------------|----------------|
| Lifetime          | 30 000 hours   |
| CRI               | > 80           |
| Body material     | aluminium      |
| Diffuser material | plastic (PMMA) |
| LGP material      | PMMA           |
| IP rating         | IP40/IP20      |



Mounting pin for flush mounting



Photometric data available at [www.emos.eu/LDT](http://www.emos.eu/LDT)

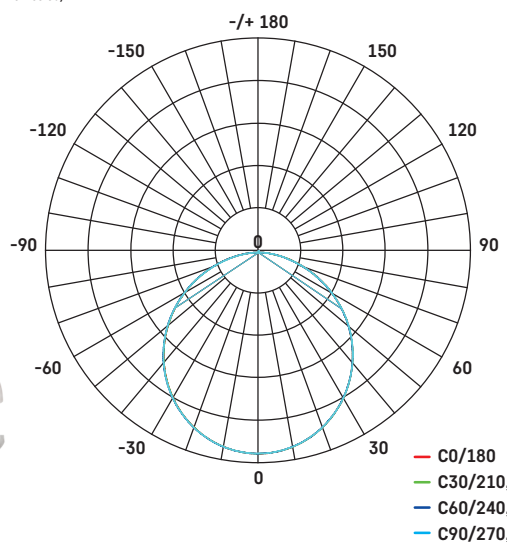

3 000 K  
3 500 K  
4 000 K



Adjustable during installation



**Set with additional dimmable driver**

| Type    | Panel  | + | Dimmable power supply |
|---------|--------|---|-----------------------|
| ZD2333T | ZD2333 | + | ZZ1435T               |
| ZD2343T | ZD2343 | + | ZZ2055T               |

See page 134



3 000 K



3 500 K



4 000 K

# EXTENSIO

Elegant and timeless EXTENSIO LED luminaires with a choice of lighting modes are designed for modern interiors. Changing the lighting mode can be done with a conventional switch. Without the need for any additional adjustments in the cabling, they thus allow you to continue working with light in the interior.

**Main benefits:**

- 3 lighting modes
- halo effect – night mode feature
- no memory function

**Areas of use:** illumination of modern interiors, spaces and hallways in offices, hotels and households.

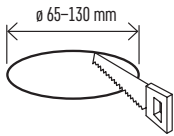

**ZD1312**

1/-/4/40

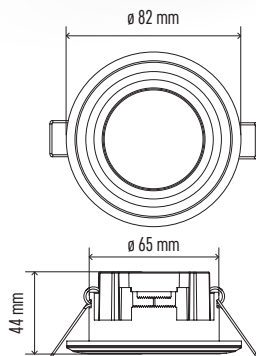

**ZD1322**

1/-/-/18

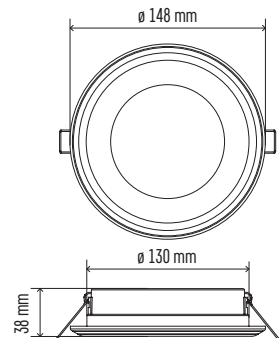

| Type   | EAN           | Power | Luminous Flux | CCT     | PF    | Flicker-Free | Diameter × D     |
|--------|---------------|-------|---------------|---------|-------|--------------|------------------|
| ZD1312 | 8592920075968 | 5,5 W | 420 lm        | 4 000 K | > 0.5 | yes          | ø 82 mm × 44 mm  |
| ZD1322 | 8592920076026 | 13 W  | 1 000 lm      | 4 000 K | > 0.5 | yes          | ø 148 mm × 38 mm |



|                   |              |
|-------------------|--------------|
| Lifetime          | 25 000 hours |
| CRI               | > 80         |
| Body material     | plastic (PC) |
| Diffuser material | plastic (PC) |
| IP rating         | IP20         |



Photometric data  
available at  
[www.emos.eu/LDT](http://www.emos.eu/LDT)

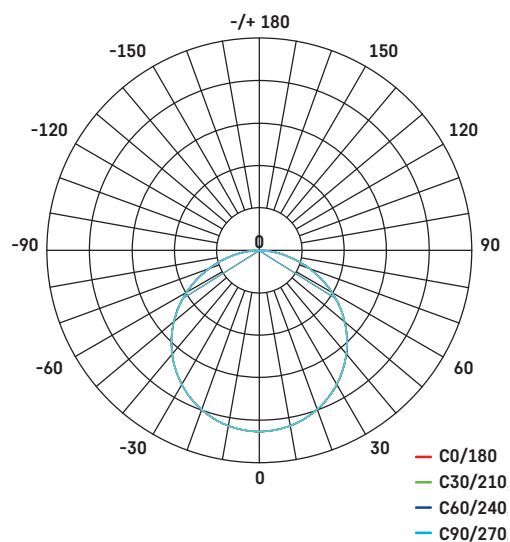

1× 



2× 



3× 

# RUBIC

Practical LED luminaires of the RUBIC series in white are made of high-quality plastic and are designed to be recessed into plasterboard. With regard to the materials used, their long service life with minimal loss of luminosity is ensured.

**Main benefits:**

- high luminous efficacy
- conservative design
- integrated driver

**Areas of use:** indoor lighting in households.

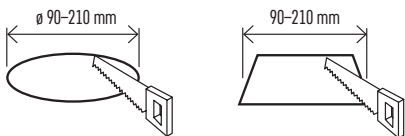

Mounting pin for flush mounting



**ZD1432**

1/-/-/45

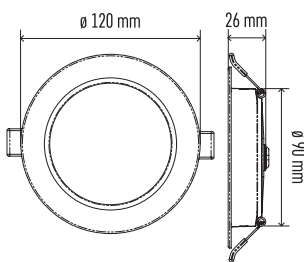

**ZD1442**

1/-/-/32

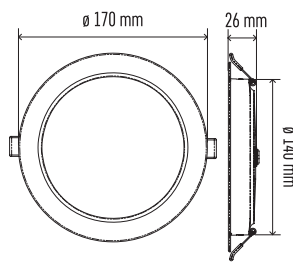

**ZD1452**

1/-/-/16

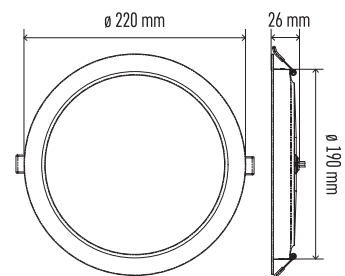

| Type   | EAN           | Power | Luminous Flux | CCT     | PF    | Flicker-Free | Diameter × D     |
|--------|---------------|-------|---------------|---------|-------|--------------|------------------|
| ZD1432 | 8592920108819 | 9 W   | 900 lm        | 4 000 K | > 0.5 | no           | ø 120 mm × 26 mm |
| ZD1442 | 8592920108765 | 18 W  | 1 800 lm      | 4 000 K | > 0.7 | no           | ø 170 mm × 26 mm |
| ZD1452 | 8592920108703 | 24 W  | 2 400 lm      | 4 000 K | > 0.7 | no           | ø 220 mm × 26 mm |



|                   |              |
|-------------------|--------------|
| Lifetime          | 25 000 hours |
| CRI               | > 80         |
| Body material     | plastic (PC) |
| Diffuser material | plastic (PC) |
| IP rating         | IP20         |



Photometric data available at [www.emos.eu/LDT](http://www.emos.eu/LDT)

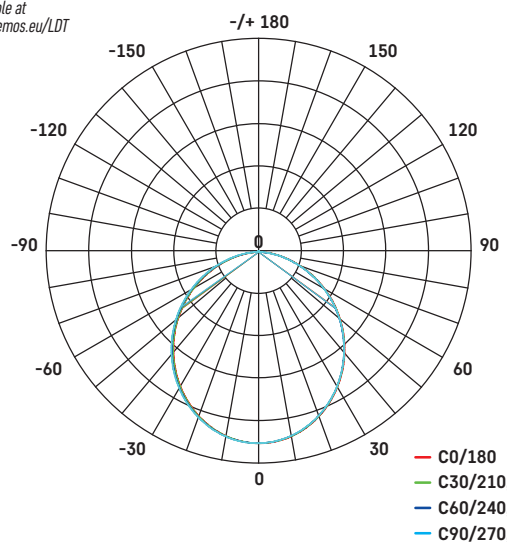

**ZD2432**

1/-/-/45

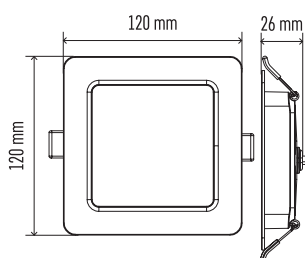

**ZD2442**

1/-/-/32

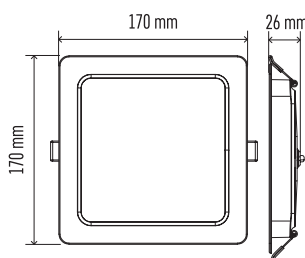

**ZD2452**

1/-/-/16

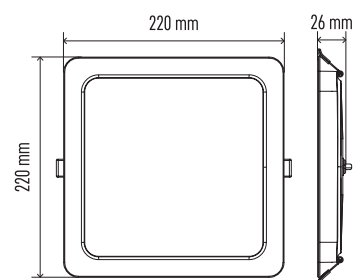

| Type   | EAN           | Power | Luminous Flux | CCT     | PF    | Flicker-Free | W × H × D         |
|--------|---------------|-------|---------------|---------|-------|--------------|-------------------|
| ZD2432 | 8592920108642 | 9 W   | 900 lm        | 4 000 K | > 0.5 | no           | 120 × 120 × 26 mm |
| ZD2442 | 8592920108604 | 18 W  | 1 800 lm      | 4 000 K | > 0.7 | no           | 170 × 170 × 26 mm |
| ZD2452 | 8592920108550 | 24 W  | 2 400 lm      | 4 000 K | > 0.7 | no           | 220 × 220 × 26 mm |

# Industrial Luminaires

## HIGHBAYS

### ASTER

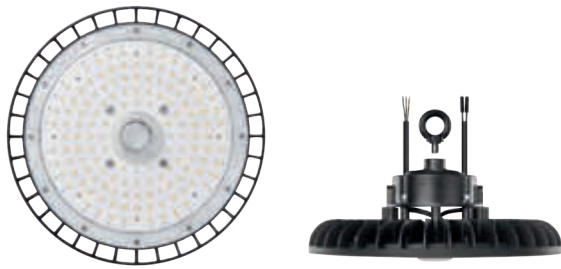
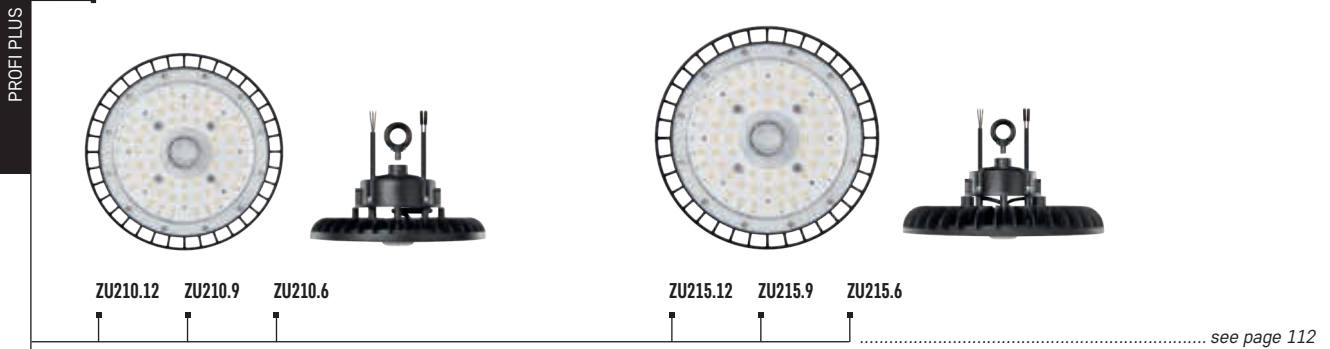



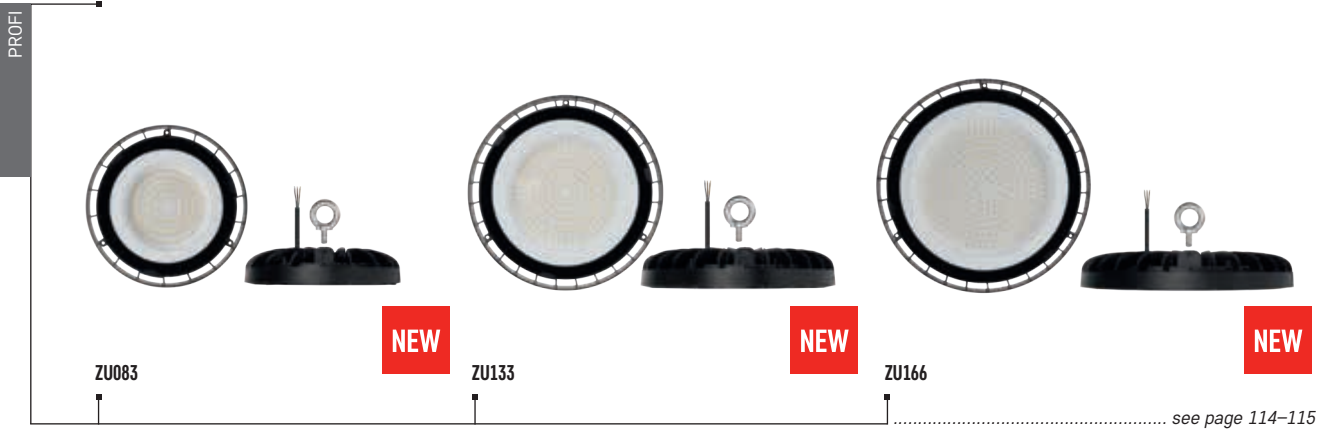



### CORUS











ACCESSORIES FOR HIGHBAYS

|   |   |   |
|---|---|---|
|  |  |  |
| ZU9001  | ZU9002  | ZU9902  |
| ..... see page 116  |   |   |
|  |  |  |
| ZU9003  | ZU9004  | ZU9905  |
| <b>NEW</b>  | <b>NEW</b>  | <b>NEW</b>  |
| ..... see page 116  |   |   |

DUSTPROOF LUMINAIRES

MISTY

|                   |   |   |  |
|-------------------|---|---|--|
| <b>PROFI PLUS</b> |  |  |  |
|                   |  |  |  |
|                   | ZT1040  | ZT1521  | ZT1531   |
|                   | <b>NEW</b>  | ZT1621  | ZT1631   |
|                   |   | ZT1520  | ZT1530   |
|                   |   | ZT1520D   | ZT1520E  |
|                   |   | ZT1620  | ZT1630   |
|                   |   | ZT1620D   | ZT1620E  |
|                   | ..... see page 118-119  |   |  |

FESTY

|              |   |   |  |
|--------------|---|---|--|
| <b>PROFI</b> |  |  |  |
|              |   |   |  |
|              | ZT4020  | ZT4120  | ZT4220   |
|              | ..... see page 120  |   |  |

DUSTY

|                  |   |   |  |
|------------------|---|---|--|
| <b>ESSENTIAL</b> |  |  |  |
|                  |   |   |  |
|                  | ZT3020  | ZT3120  | ZT3220   |
|                  | ..... see page 121  |   |  |

# ASTER

ASTER high bay luminaires are designed for professional industrial installations at high heights, especially in warehouses and production areas. The luminaires are equipped with Osram branded LED chips with a luminous efficacy of 170 lm/W and a long service life.

### Main benefits:

- IP65 rating ensures water resistance
- outstanding performance and light quality – CRI > 80
- option for dimming using accessories (0–10 V, DALI)

### Areas of use:

industrial and warehouse buildings, large halls.

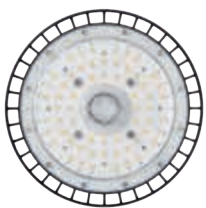

### ZU210.12

☐ 1/-/-/1

### ZU210.9

☐ 1/-/-/1

### ZU210.6 To Order

☐ 1/-/-/1

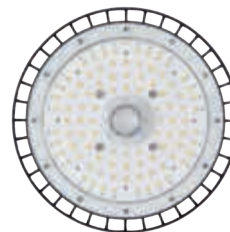

### ZU215.12

☐ 1/-/-/1

### ZU215.9

☐ 1/-/-/1

### ZU215.6

☐ 1/-/-/1

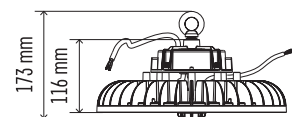
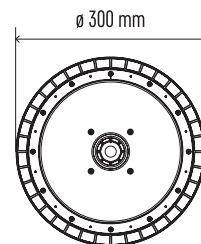
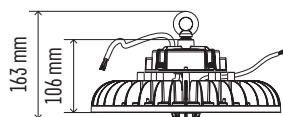
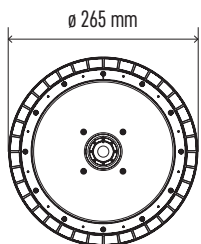

| Type     | EAN           | Power | Luminous Flux | CCT     | PF    | Beam Angle | Luminous Efficacy | Flicker-Free | Dimmable | Diameter × D   |
|----------|---------------|-------|---------------|---------|-------|------------|-------------------|--------------|----------|----------------|
| ZU210.12 | 8592920096420 | 100 W | 17 000 lm     | 4 000 K | > 0.9 | 120°       | 170 lm/W          | yes          | no       | ø 265 × 163 mm |
| ZU210.9  | 8592920096468 | 100 W | 17 000 lm     | 4 000 K | > 0.9 | 90°        | 170 lm/W          | yes          | no       | ø 265 × 163 mm |
| ZU210.6  | 8592920096444 | 100 W | 17 000 lm     | 4 000 K | > 0.9 | 60°        | 170 lm/W          | yes          | no       | ø 265 × 163 mm |
| ZU215.12 | 8592920096482 | 150 W | 25 500 lm     | 4 000 K | > 0.9 | 120°       | 170 lm/W          | yes          | no       | ø 300 × 173 mm |
| ZU215.9  | 8592920096529 | 150 W | 25 500 lm     | 4 000 K | > 0.9 | 90°        | 170 lm/W          | yes          | no       | ø 300 × 173 mm |
| ZU215.6  | 8592920096505 | 150 W | 25 500 lm     | 4 000 K | > 0.9 | 60°        | 170 lm/W          | yes          | no       | ø 300 × 173 mm |

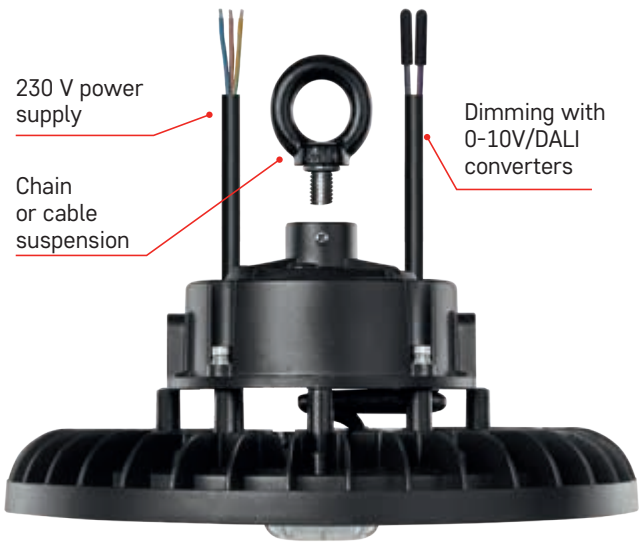

|                   |              |
|-------------------|--------------|
| Lifetime          | 50 000 hours |
| CRI               | > 80         |
| Body material     | aluminium    |
| Diffuser material | plastic (PC) |
| IP rating         | IP65         |
| IK                | IK08         |



Photometric data available at [www.emos.eu/LDT](http://www.emos.eu/LDT)

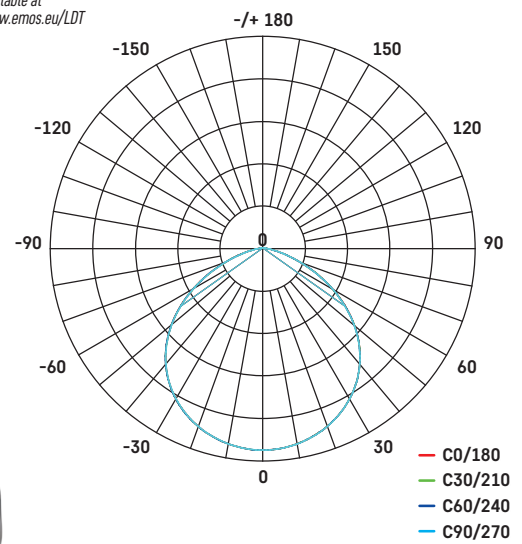

Option to hang the luminaire on a chain or on a cable

### ZU220.12

⊠ 1/-/-1

### ZU220.9

⊠ 1/-/-1

### ZU220.6

⊠ 1/-/-1

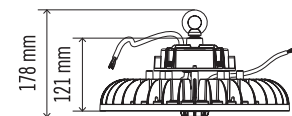
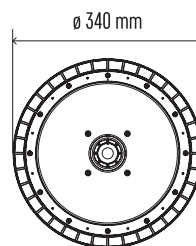

| Type     | EAN           | Power | Luminous Flux | CCT     | PF    | Beam Angle | Luminous Efficacy | Flicker-Free | Dimmable | Diameter × D   |
|----------|---------------|-------|---------------|---------|-------|------------|-------------------|--------------|----------|----------------|
| ZU220.12 | 8592920096543 | 200 W | 34 000 lm     | 4 000 K | > 0.9 | 120°       | 170 lm/W          | yes          | no       | ∅ 340 × 178 mm |
| ZU220.9  | 8592920096581 | 200 W | 34 000 lm     | 4 000 K | > 0.9 | 90°        | 170 lm/W          | yes          | no       | ∅ 340 × 178 mm |
| ZU220.6  | 8592920096567 | 200 W | 34 000 lm     | 4 000 K | > 0.9 | 60°        | 170 lm/W          | yes          | no       | ∅ 340 × 178 mm |

# CORUS

CORUS highbay luminaires are ideal for professional industrial installations in areas with high ceilings, especially in large warehouses and production halls. These luminaires are characterized by high luminous efficiency, quality of illumination and long lifespan.

#### Main benefits:

- IP65 coverage guarantees water resistance
- High luminous efficiency of 120 lm/W

#### Areas of use:

industrial and warehouse buildings, large halls.



#### ZU083

1/-/-/3

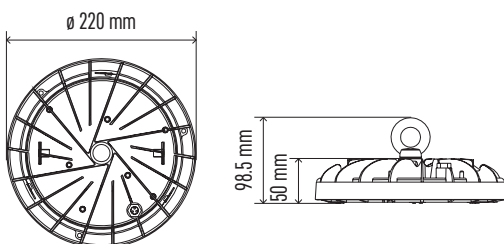

#### ZU133

1/-/-/3

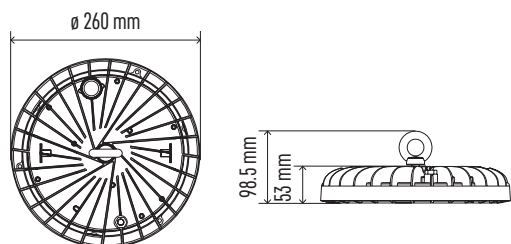

| Type  | EAN           | Power | Luminous Flux | CCT     | PF    | Beam Angle | Luminous Efficacy | Flicker-Free | Dimmable | Diameter × D  |
|-------|---------------|-------|---------------|---------|-------|------------|-------------------|--------------|----------|---------------|
| ZU083 | 8592920122167 | 83 W  | 10 000 lm     | 4 000 K | > 0.9 | 110°       | 120 lm/W          | yes          | no       | ø 220 × 50 mm |
| ZU133 | 8592920122181 | 133 W | 16 000 lm     | 4 000 K | > 0.9 | 110°       | 120 lm/W          | yes          | no       | ø 260 × 53 mm |

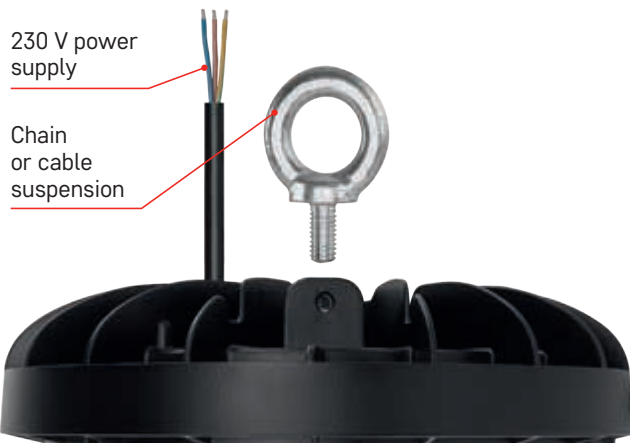

|                   |              |
|-------------------|--------------|
| Lifetime          | 50 000 hours |
| CRI               | > 80         |
| Body material     | aluminium    |
| Diffuser material | glass        |
| IP rating         | IP65         |
| IK                | IK06         |



Photometric data available at [www.emos.eu/LDT](http://www.emos.eu/LDT)

**NEW**

**5 YEARS WARRANTY**

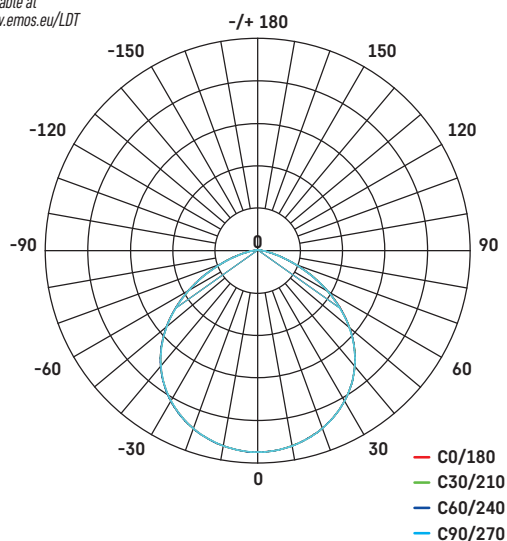

## ZU166

1/-/-/3

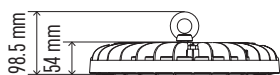
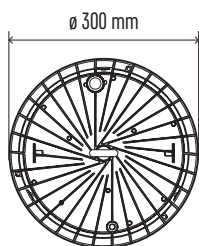

| Type  | EAN           | Power | Luminous Flux | CCT     | PF    | Beam Angle | Luminous Efficacy | Flicker-Free | Dimmable | Diameter × D  |
|-------|---------------|-------|---------------|---------|-------|------------|-------------------|--------------|----------|---------------|
| ZU166 | 8592920122204 | 166 W | 20 000 lm     | 4 000 K | > 0.9 | 110°       | 120 lm/W          | yes          | no       | ø 300 × 54 mm |

# ACCESSORIES FOR HIGHBAYS

In the accessories for highbay luminaires you will find quality converters for industrial luminaires and additional brackets.



## ZU9001

**0-10 V CONVERTER FOR HIGHBAY INDUSTRIAL LUMINAIRES**  
plastic (PC) + metal

1/-/-144

## ZU9002

**DALI CONVERTER FOR HIGHBAY INDUSTRIAL LUMINAIRES**  
plastic (PC) + metal

1/-/-144



| Type   | EAN           | Diameter × D |
|--------|---------------|--------------|
| ZU9001 | 8592920096628 | ø 55 × 29 mm |
| ZU9002 | 8592920096642 | ø 55 × 29 mm |

## ZU9902

**ADDITIONAL HOLDER FOR HIGHBAY INDUSTRIAL LUMINAIRES**  
aluminium

1/-/-20



| Type   | EAN           | W × H × D         |
|--------|---------------|-------------------|
| ZU9902 | 8592920109618 | 60 × 265 × 125 mm |



## ZU9003

**PIR SENSOR FOR LED HIGHBAY**

1/-/-196

**NEW**

| Type   | EAN           | W × H × D           |
|--------|---------------|---------------------|
| ZU9903 | 8592920121405 | diameter 55 × 40 mm |
| ZU9904 | 8592920121429 | diameter 55 × 29 mm |
| ZU9905 | 8592920121443 | 125 × 70 × 25 mm    |



## ZU9004

**MW SENSOR FOR LED HIGHBAY**

1/-/-144

**NEW**



## ZU9005

**REMOTE CONTROLLER FOR SENSORS FOR LED HIGHBAY**

1/-/-81

**NEW**

**EMOS®**

A brand of **legrand**



# MISTY

MISTY luminaires are designed for professional industrial installations and replace older fluorescent luminaires. They are characterised by their modern design, high luminous efficacy up to 145 lm/W, long life and instant 100% output.

**Main benefits:**

- energy saving up to 50% compared to fluorescent luminaires
- IP66 protection guarantees water resistance
- extended warranty 5 years

**Areas of use:** industrial and warehouse buildings, garages, corridors, workshops, etc.

|                   |              |
|-------------------|--------------|
| Lifetime          | 50 000 hours |
| CRI               | > 80         |
| Body material     | plastic (PC) |
| Diffuser material | plastic (PC) |
| IP rating         | IP66         |
| IK                | IK08         |



Photometric data available at [www.emos.eu/LDT](http://www.emos.eu/LDT)

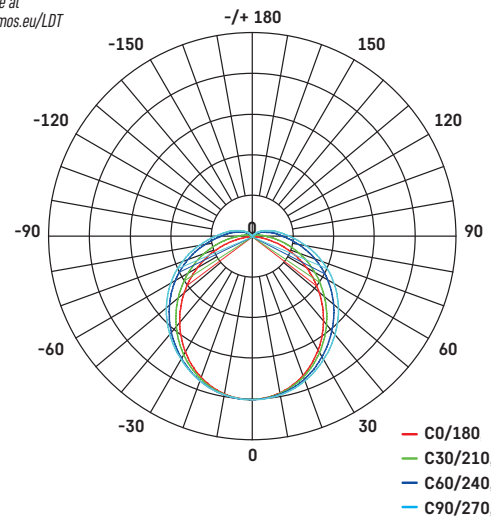

**ZT1040**

☐ 1/-/-12

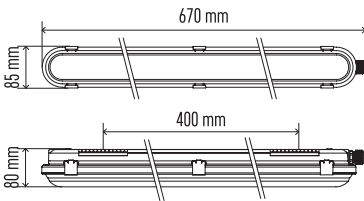

**ZT1521**

☐ 1/-/-9

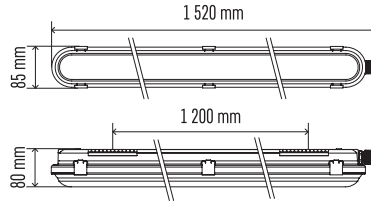

**ZT1531**

☐ 1/-/-9

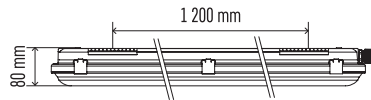

**ZT1621**

☐ 1/-/-9

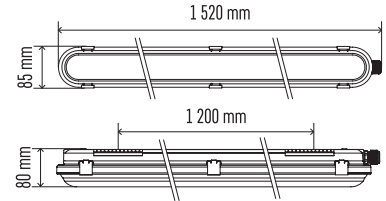

**ZT1631**

☐ 1/-/-9

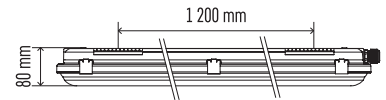

| Type   | EAN           | Power         | Luminous Flux  | CCT           | PF    | Luminous Efficacy | Through-Wiring | W × H × D          |
|--------|---------------|---------------|----------------|---------------|-------|-------------------|----------------|--------------------|
| ZT1040 | 8592920122884 | 10–13–16–18 W | 1 500–2 700 lm | 4 000–6 500 K | > 0.9 | 150 lm/W          | yes            | 670 × 85 × 80 mm   |
| ZT1521 | 8592920122808 | 21–26–31–35 W | 3 300–5 600 lm | 4 000 K       | > 0.9 | 160 lm/W          | yes            | 1 220 × 85 × 80 mm |
| ZT1531 | 8592920122822 | 21–26–31–35 W | 3 300–5 600 lm | 6 500 K       | > 0.9 | 160 lm/W          | yes            | 1 220 × 85 × 80 mm |
| ZT1621 | 8592920122846 | 29–37–45–51 W | 4 600–8 150 lm | 4 000 K       | > 0.9 | 160 lm/W          | yes            | 1 520 × 85 × 80 mm |
| ZT1631 | 8592920122860 | 29–37–45–51 W | 4 600–8 150 lm | 6 500 K       | > 0.9 | 160 lm/W          | yes            | 1 520 × 85 × 80 mm |



Option to adjust the light temperature using the CCT switch (only for ZT1040)



Option to set up the power input



Easily removable diffuser



|                   |              |
|-------------------|--------------|
| Lifetime          | 50 000 hours |
| CRI               | > 80         |
| Body material     | plastic (PC) |
| Diffuser material | plastic (PC) |
| IP rating         | IP66         |
| IK                | IK08         |



Photometric data available at [www.emos.eu/LDT](http://www.emos.eu/LDT)

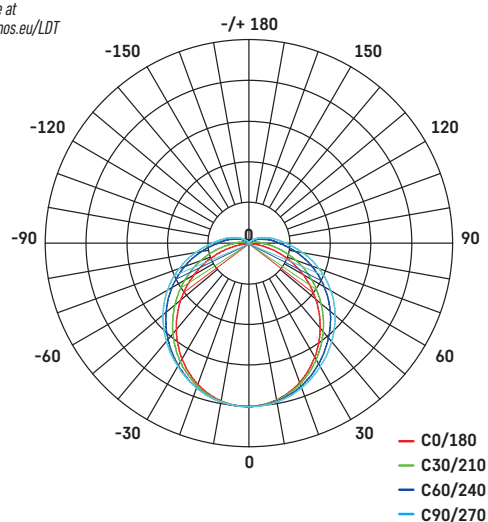

### ZT1520

1/-/-/9

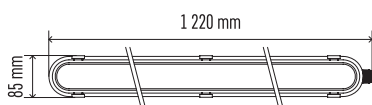

### ZT1530

1/-/-/9

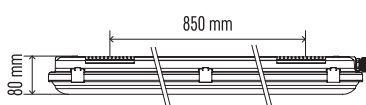

### ZT1520D

1/-/-/9

### ZT1520E

1/-/-/9

Battery type: LiFePO4  
Backup time: 3 hours  
Lumen output in emergency mode: 630 lm



| Type    | EAN           | Power | Luminous Flux | CCT     | PF    | Luminous Efficacy | Through-Wiring | W × H × D          |
|---------|---------------|-------|---------------|---------|-------|-------------------|----------------|--------------------|
| ZT1520  | 8592920091951 | 37 W  | 5 300 lm      | 4 000 K | > 0.9 | 143 lm/W          | yes            | 1 220 × 85 × 80 mm |
| ZT1530  | 8592920091999 | 37 W  | 5 300 lm      | 6 500 K | > 0.9 | 145 lm/W          | yes            | 1 220 × 85 × 80 mm |
| ZT1520D | 8592920093054 | 37 W  | 5 300 lm      | 4 000 K | > 0.9 | 143 lm/W          | yes            | 1 220 × 85 × 80 mm |
| ZT1520E | 8592920093092 | 40 W  | 5 300 lm      | 4 000 K | > 0.9 | 143 lm/W          | yes            | 1 220 × 85 × 80 mm |

### ZT1620

1/-/-/9

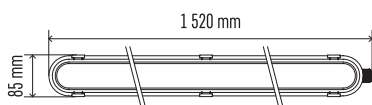

### ZT1630

1/-/-/9

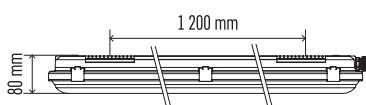

### ZT1620D

1/-/-/9

### ZT1620E

1/-/-/9

Battery type: LiFePO4  
Backup time: 3 hours  
Lumen output in emergency mode: 630 lm



| Type    | EAN           | Power | Luminous Flux | CCT     | PF    | Luminous Efficacy | Through-Wiring | W × H × D          |
|---------|---------------|-------|---------------|---------|-------|-------------------|----------------|--------------------|
| ZT1620  | 8592920091975 | 53 W  | 7 700 lm      | 4 000 K | > 0.9 | 145 lm/W          | yes            | 1 520 × 85 × 80 mm |
| ZT1630  | 8592920092019 | 53 W  | 7 700 lm      | 6 500 K | > 0.9 | 145 lm/W          | yes            | 1 520 × 85 × 80 mm |
| ZT1620D | 8592920093078 | 53 W  | 7 700 lm      | 4 000 K | > 0.9 | 145 lm/W          | yes            | 1 520 × 85 × 80 mm |
| ZT1620E | 8592920093115 | 56 W  | 7 700 lm      | 4 000 K | > 0.9 | 145 lm/W          | yes            | 1 520 × 85 × 80 mm |

# FESTY

FESTY luminaires are designed for semi-professional industrial installations and replace older fluorescent luminaires. They are characterised by their modern design, excellent price/quality ratio, long service life and instant 100% output.

### Main benefits:

- energy saving up to 50% compared to fluorescent luminaires
- IP65 protection guarantees water resistance
- extended warranty 3 years

**Areas of use:** industrial and warehouse buildings, garages, corridors, workshops, etc.



### ZT4320

1/-/-/10

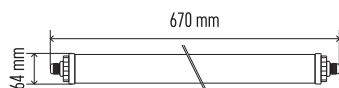

### ZT4420

1/-/-/10

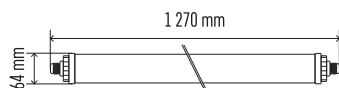

### ZT4520

1/-/-/10

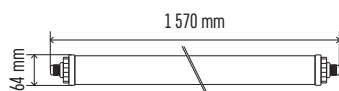

|                   |              |
|-------------------|--------------|
| Lifetime          | 50 000 hours |
| CRI               | > 80         |
| Body material     | plastic (PC) |
| Diffuser material | plastic (PC) |
| IP rating         | IP65         |
| IK                | IK08         |



Photometric data  
available at  
[www.emos.eu/LDT](http://www.emos.eu/LDT)

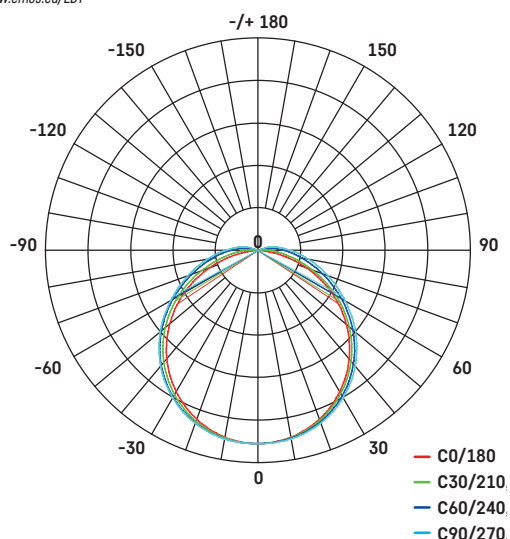

| Type   | EAN           | Power | Luminous Flux | CCT     | PF    | Luminous Efficacy | Through-Wiring | W × H × D          |
|--------|---------------|-------|---------------|---------|-------|-------------------|----------------|--------------------|
| ZT4320 | 8592920118320 | 18 W  | 2 200 lm      | 4 000 K | > 0.9 | 120 lm/W          | yes            | 670 × 64 × 64 mm   |
| ZT4420 | 8592920118344 | 34 W  | 4 100 lm      | 4 000 K | > 0.9 | 120 lm/W          | yes            | 1 270 × 64 × 64 mm |
| ZT4520 | 8592920118368 | 51 W  | 6 000 lm      | 4 000 K | > 0.9 | 120 lm/W          | yes            | 1 570 × 64 × 64 mm |

# DUSTY

DUSTY luminaires are designed for standard industrial installations and replace older fluorescent luminaires. The luminaires have an instantaneous 100% output.

### Main benefits:

- energy saving up to 50% compared to fluorescent luminaires
- IP65 protection guarantees water resistance
- possibility of pass-through connection

**Areas of use:** industrial and warehouse buildings, garages, corridors, workshops, etc.

|                   |              |
|-------------------|--------------|
| Lifetime          | 30 000 hours |
| CRI               | > 80         |
| Body material     | plastic (PC) |
| Diffuser material | plastic (PC) |
| IP rating         | IP65         |
| IK                | IK08         |



Photometric data available at [www.emos.eu/LDT](http://www.emos.eu/LDT)

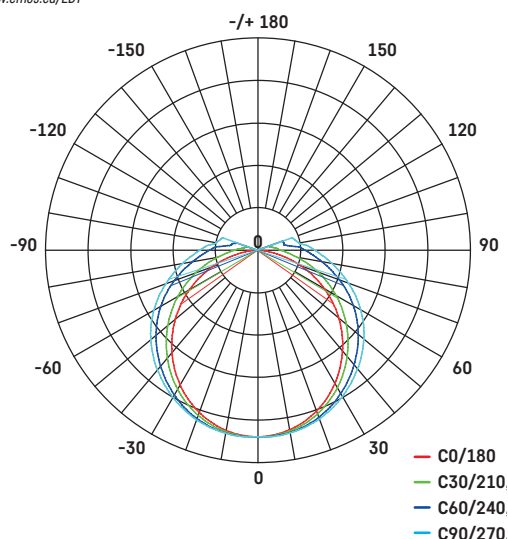

### ZT3020

1/-/-/20

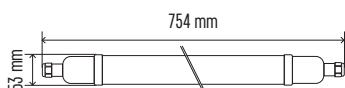

### ZT3120

1/-/-/20

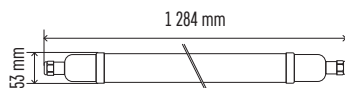

### ZT3220



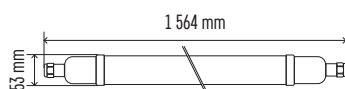





1/-/-/20



| Type   | EAN           | Power | Luminous Flux | CCT     | PF    | Luminous Efficacy | Through-Wiring | W × H × D          |
|--------|---------------|-------|---------------|---------|-------|-------------------|----------------|--------------------|
| ZT3020 | 8592920085448 | 18 W  | 1 700 lm      | 4 000 K | > 0.5 | 95 lm/W           | yes            | 754 × 53 × 35 mm   |
| ZT3120 | 8592920085455 | 37 W  | 3 800 lm      | 4 000 K | > 0.9 | 103 lm/W          | yes            | 1 284 × 53 × 35 mm |
| ZT3220 | 8592920085462 | 45 W  | 4 500 lm      | 4 000 K | > 0.9 | 100 lm/W          | yes            | 1 564 × 53 × 35 mm |

# Luminaires for special applications

## ORIENTATION LUMINAIRES

|         |       |   |   |   |  |                    |
|---------|-------|---|---|---|--|--------------------|
| CLASSIC | AMAL  |    |    |    |  |                    |
|         |       | ZC0108  | ZC0110  | ZC0109  | ZC0111   | ..... see page 124 |
|         | DIRAL |   |  |   |  |                    |
|         |       | ZC0105  | ZC0106  |   |  | ..... see page 125 |
| CLASSIC | DIRBY |  |  |  |  |                    |
|         |       | ZC0114  | ZC0116  | ZC0117  |  | ..... see page 126 |

## EMERGENCY LUMINAIRES

ORSU



CESSI AND NESSI



## ACCESSORIES FOR EMERGENCY LIGHTS

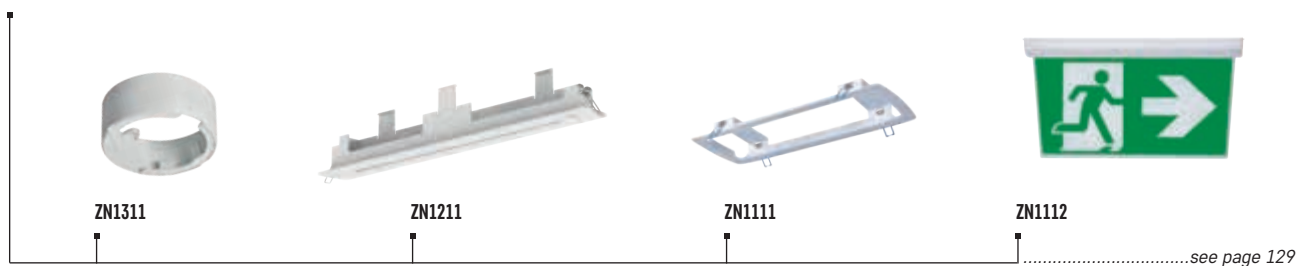

## CABINET LUMINAIRES

TIGO



# AMAL

AMAL orientation luminaires in brushed aluminium are designed for recessed mounting. The aluminium body and glass milk diffuser guarantee a superior service life.

**Main benefits:**

- minimal power consumption
- IP65 rating ensures water resistance
- in neutral or warm white

**Areas of use:** in the household and industrial spaces, for staircase lighting, house facades, walls etc.

|                   |              |
|-------------------|--------------|
| Lifetime          | 30 000 hours |
| CRI               | > 80         |
| Body material     | aluminium    |
| Diffuser material | glass        |
| IP rating         | IP65         |



**ZC0108**

1/-/-/24

**ZC0110**

1/-/-/24

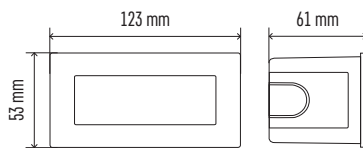

**ZC0109**

1/-/-/24

**ZC0111**

1/-/-/24

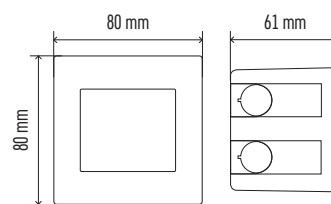

| Type   | EAN           | Power | Luminous Flux | CCT     | PF    | Luminous Efficacy | Through-Wiring | W × H × D        |
|--------|---------------|-------|---------------|---------|-------|-------------------|----------------|------------------|
| ZC0108 | 8592920037348 | 1.5 W | 55 lm         | 3 000 K | > 0.5 | 37 lm/W           | yes            | 123 × 53 × 61 mm |
| ZC0109 | 8592920037355 | 1.5 W | 75 lm         | 3 000 K | > 0.5 | 50 lm/W           | yes            | 80 × 80 × 61 mm  |
| ZC0110 | 8592920054789 | 1.5 W | 55 lm         | 4 000 K | > 0.5 | 37 lm/W           | yes            | 123 × 53 × 61 mm |
| ZC0111 | 8592920054796 | 2 W   | 70 lm         | 4 000 K | > 0.5 | 50 lm/W           | yes            | 80 × 80 × 61 mm  |

## DIRAL

DIRAL orientation luminaires are available in several shapes and sizes and are designed for built-in installation. The aluminium body and glass milk diffuser guarantee a superior service life.

### Main benefits:

- minimal power consumption
- IP65 rating ensures water resistance
- for indoor and outdoor areas

**Areas of use:** in the household and industrial spaces, for staircase lighting, house facades, walls etc.

|                   |              |
|-------------------|--------------|
| Lifetime          | 30 000 hours |
| CRI               | > 80         |
| Body material     | aluminium    |
| Diffuser material | glass        |
| IP rating         | IP65         |



**ZC0105**

1/-/-/16

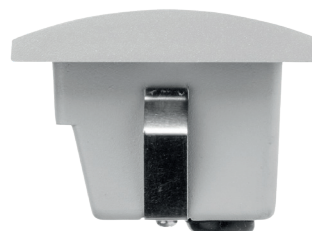
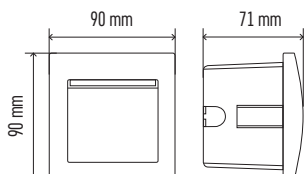

**ZC0106**

1/-/-/16

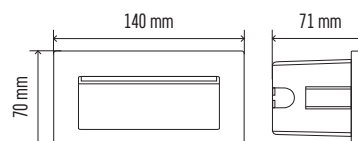

| Type   | EAN           | Power | Luminous Flux | CCT     | PF    | Luminous Efficacy | Through-Wiring | W × H × D        |
|--------|---------------|-------|---------------|---------|-------|-------------------|----------------|------------------|
| ZC0105 | 8592920037317 | 1 W   | 25 lm         | 3 000 K | > 0.5 | 25 lm/W           | yes            | 90 × 90 × 71 mm  |
| ZC0106 | 8592920037324 | 3 W   | 90 lm         | 3 000 K | > 0.5 | 30 lm/W           | yes            | 140 × 70 × 71 mm |

# DIRBY

DIRBY orientation luminaires for surface-mounted installation are particularly attractive due to their excellent price/quality ratio and the available range of shapes. The ABS plastic body and polycarbonate diffuser guarantee a long service life.

**Main benefits:**

- minimal power consumption
- IP65 rating ensures water resistance
- for indoor and outdoor areas

**Areas of use:** in the household and industrial spaces, for staircase lighting, house facades, walls etc.

|                   |               |
|-------------------|---------------|
| Lifetime          | 30 000 hours  |
| CRI               | > 80          |
| Body material     | ABS           |
| Diffuser material | polycarbonate |
| IP rating         | IP65          |



**ZC0114**

1/-/-/18

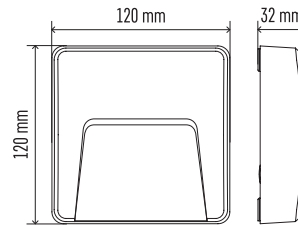

| Type   | EAN           | Power | Luminous Flux | CCT     | PF    | Luminous Efficacy | Through-Wiring | W × H × D         |
|--------|---------------|-------|---------------|---------|-------|-------------------|----------------|-------------------|
| ZC0114 | 8592920075586 | 3 W   | 100 lm        | 4 000 K | > 0.5 | 33 lm/W           | yes            | 120 × 120 × 32 mm |



**ZC0116**

1/-/-/40

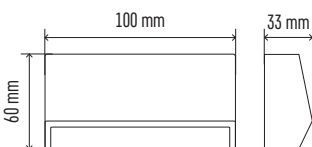

**ZC0117**

1/-/-/30

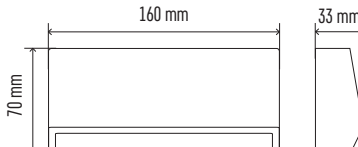

| Type   | EAN           | Power | Luminous Flux | CCT     | PF    | Luminous Efficacy | Through-Wiring | W × H × D        |
|--------|---------------|-------|---------------|---------|-------|-------------------|----------------|------------------|
| ZC0116 | 8592920075609 | 1.5 W | 80 lm         | 4 000 K | > 0.5 | 53 lm/W           | yes            | 100 × 60 × 33 mm |
| ZC0117 | 8592920075616 | 3 W   | 150 lm        | 4 000 K | > 0.5 | 50 lm/W           | yes            | 160 × 70 × 33 mm |



# ORSU

Body material

plastic (PC)

IP rating

IP20

**4**  
YEARS  
WARRANTY

The ORSU emergency luminaire serves as lighting in the event of a power failure and ensures safe egress from rooms during a power outage or other hazard.

**Main benefits:**

- sufficient backup power for 3 hours during a power outage
- test button and LED indicator for testing functionality
- extended 4-year warranty

**Areas of use:** industrial and warehouse buildings, garages, hallways, offices, etc.



## ZN1310

1/-/-12

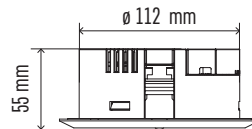
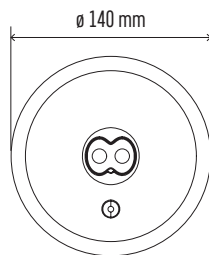

| Type   | EAN           | Power | Luminous Flux | CCT     | PF   | Battery Type | Backup Power | Operating Mode | Diameter × D  |
|--------|---------------|-------|---------------|---------|------|--------------|--------------|----------------|---------------|
| ZN1310 | 8592920091081 | 3 W   | 240 lm        | 6 500 K | >0.5 | LiFePo4      | 3 h          | standby        | ø 140 × 55 mm |

## ZR9310

1/-/-20

**3**  
YEARS  
WARRANTY

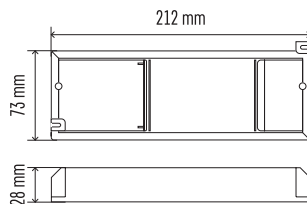

| Type   | EAN           | Power | Luminous Flux | CCT | PF   | Battery Type | Backup Power | Operating Mode | W × H × D        |
|--------|---------------|-------|---------------|-----|------|--------------|--------------|----------------|------------------|
| ZR9310 | 8592920086001 | -     | -             | -   | >0.6 | LiFePo4      | 1 h          | -              | 212 × 73 × 28 mm |

# CESSI A NESSI

The CESSI and NESSI emergency luminaires serve as lighting in the event of a power failure and ensures safe egress from rooms during a power outage or other crisis situation.

## Main benefits:

- sufficient backup power for 3 hours during a power outage
- test button and LED indicator for testing functionality
- extended 4-year warranty

**Areas of use:** industrial and warehouse buildings, garages, hallways, offices, etc.

Body material

plastic (PC)  
plastic (ABS)

IP rating

IP65, IP20

4

YEARS  
WARRANTY



## ZN1210

1/-/-6

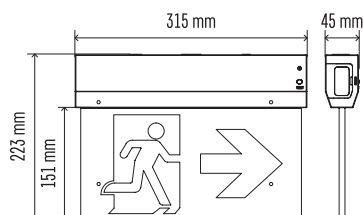

## ZN1110

1/-/-10

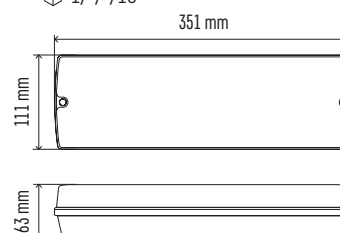

| Type   | EAN           | Power | Luminous Flux | CCT     | PF   | Battery Type | Backup Power | Operating Mode    | W × H × D         |
|--------|---------------|-------|---------------|---------|------|--------------|--------------|-------------------|-------------------|
| ZN1210 | 8592920091043 | 3 W   | 30 lm         | 5 000 K | <0.5 | Ni-Cd        | 3 h          | always-on         | 315 × 223 × 45 mm |
| ZN1110 | 8592920090640 | 3 W   | 150 lm        | 6 500 K | >0.5 | LiFePo4      | 3 h          | always-on/standby | 351 × 111 × 63 mm |

# ACCESSORIES FOR EMERGENCY LUMINAIRES



## ZN1311

FRAME  
FOR SURFACE MOUNTING  
for ZN1310

1/-/-12

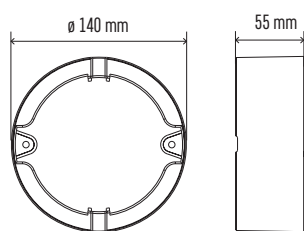

| Type   | EAN           | Diameter × D  |
|--------|---------------|---------------|
| ZN1311 | 8592920091104 | ∅ 140 × 55 mm |



## ZN1211

FRAME  
FOR RECESSED MOUNTING

1/-/-8

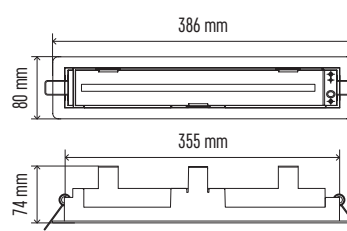

| Type   | EAN           | W × H × D        |
|--------|---------------|------------------|
| ZN1211 | 8592920091067 | 386 × 80 × 74 mm |



## ZN1111

FRAME  
FOR RECESSED MOUNTING

1/-/-10

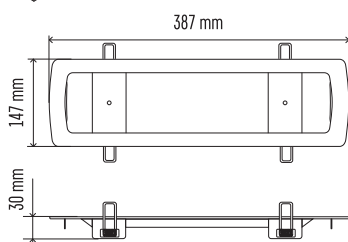

| Type   | EAN           | W × H × D         |
|--------|---------------|-------------------|
| ZN1111 | 8592920090817 | 387 × 147 × 30 mm |



## ZN1112

REPLACEMENT  
DIFFUSER

1/-/-10

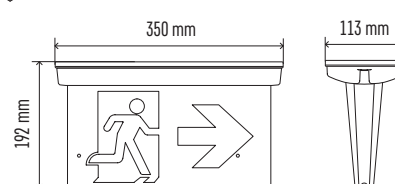

| Type   | EAN           | W × H × D          |
|--------|---------------|--------------------|
| ZN1112 | 8592920090831 | 350 × 192 × 113 mm |

# TIGO

Cabinet luminaires of the TIGO series are practical equipment for kitchens, where they serve as additional lighting under the kitchen counter.

**Main benefits:**

- possibility of interconnecting multiple lights
- high quality design with aluminium body
- easy assembly

**Areas of use:** in the household.

|                   |                |
|-------------------|----------------|
| Lifetime          | 25 000 hours   |
| CRI               | > 80           |
| Body material     | aluminium (Al) |
| Diffuser material | plastic (PC)   |
| IP rating         | IP20           |



**ZS2110**

1/-/-/30



**ZS2120**

1/-/-/30

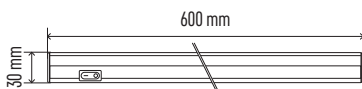

**ZS2130**

1/-/-/30

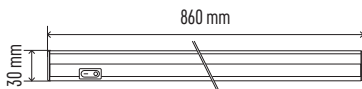

**ZS2140**

1/-/-/30

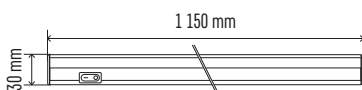

| Type   | EAN           | Power | Luminous Flux | CCT     | PF    | Luminous Efficacy | Through-Wiring | W × H × D          |
|--------|---------------|-------|---------------|---------|-------|-------------------|----------------|--------------------|
| ZS2110 | 8592920017913 | 5 W   | 500 lm        | 4 000 K | > 0.5 | 100 lm/W          | yes            | 300 × 22 × 30 mm   |
| ZS2120 | 8592920017937 | 10 W  | 1 000 lm      | 4 000 K | > 0.5 | 100 lm/W          | yes            | 600 × 22 × 30 mm   |
| ZS2130 | 8592920017951 | 15 W  | 1 500 lm      | 4 000 K | > 0.5 | 100 lm/W          | yes            | 860 × 22 × 30 mm   |
| ZS2140 | 8592920017975 | 20 W  | 2 000 lm      | 4 000 K | > 0.5 | 100 lm/W          | yes            | 1 150 × 22 × 30 mm |

# Lighting Electronics

## SENSORS

### PIR/MW SENSORS

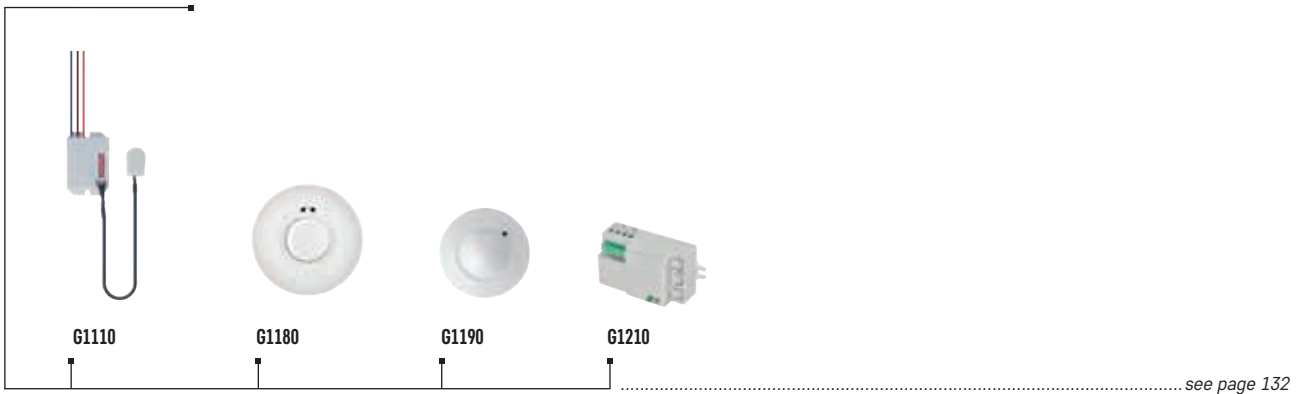

### PIR SENSORS

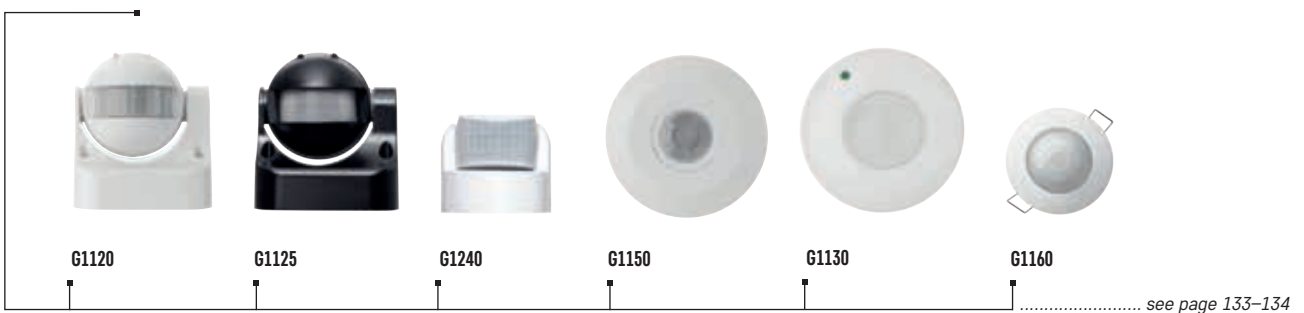

## LED DRIVERS

### LED DRIVERS

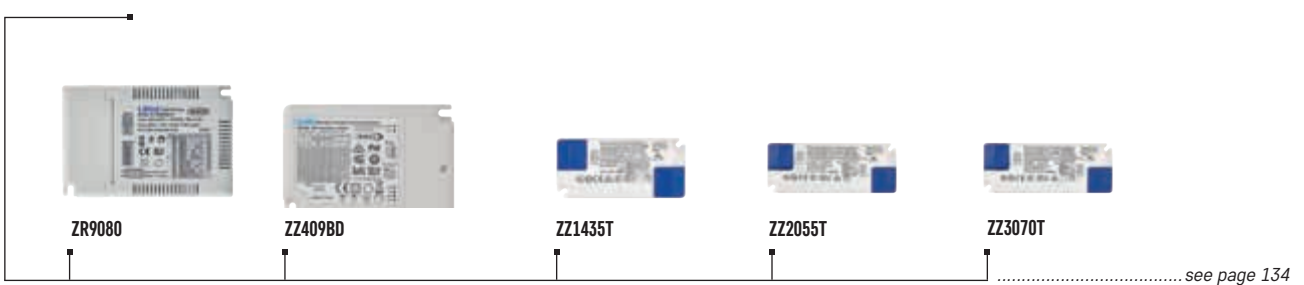

# PIR/MW SENSORS

Indoor motion detectors that act as switches for lights, outdoor spotlights or alarms. The detectors react to the movement of people, animals or other objects based on their infrared radiation emitted or reflected (called PIR sensors). Microwave versions equipped with a highly sensitive and reliable HF radio frequency sensor are also available.

**Main benefits:**

- motion sensors in various versions and designs
- 360° detection angle
- mounted and built-in models

**Areas of use:** in the household and in industrial spaces.

|               |              |
|---------------|--------------|
| Body material | plastic (PC) |
| IP rating     | IP20         |

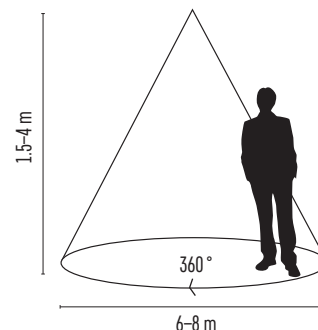

**G1110**

1/-/-/80



**G1180**

1/-/-/24



**G1190**

1/-/-/24



**G1210**

1/-/-/80

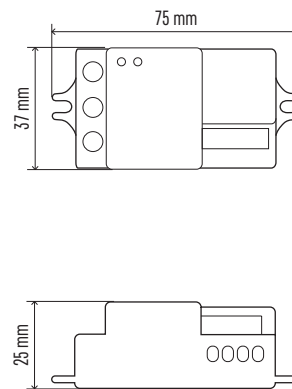
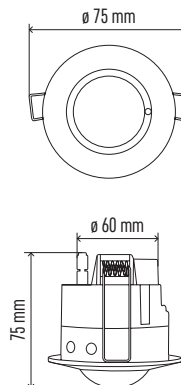
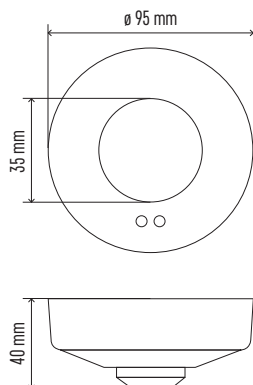
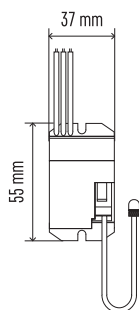

| Type  | EAN           | Detection Angle | Detection Range | Sensor Type | IP Rating | Activation time                       | W × H × D       |
|-------|---------------|-----------------|-----------------|-------------|-----------|---------------------------------------|-----------------|
| G1110 | 8592920025109 | 360°            | 6 m             | PIR         | IP20      | 5 s, 30 s, 1 min, 3 min, 5 min, 8 min | 55 × 37 × 22 mm |
| G1180 | 8592920025178 | 360°            | 8 m             | microwave   | IP20      | min. 10 seconds – max. 12 minutes     | 95 × 95 × 40 mm |
| G1190 | 8592920025185 | 360°            | 8 m             | microwave   | IP20      | min. 10 seconds – max. 12 minutes     | 75 × 75 × 75 mm |
| G1210 | 8592920025192 | 360°            | 15 m            | microwave   | IP20      | min. 10 seconds – max. 12 minutes     | 75 × 37 × 25 mm |

# PIR SENSORS

Outdoor and indoor motion detectors that function as switches for lights, outdoor spotlights or alarms. Detectors react to the movement of people, animals or other objects based on their emitted or reflected infrared radiation (called PIR sensors).

**Main benefits:**

- various designs
- 180° or 360° detection angle
- models for recessed and surface mounting

**Areas of use:** in the household and in industrial spaces.

|               |              |
|---------------|--------------|
| Body material | plastic (PC) |
| IP rating     | IP44, IP65   |

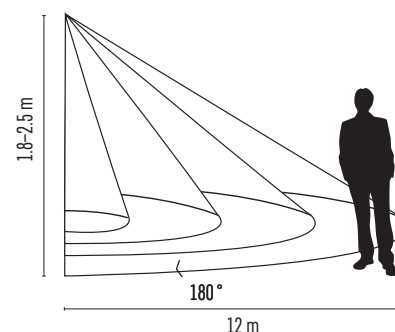

**G1120**

1/-/-/40

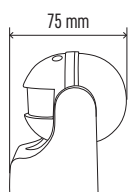
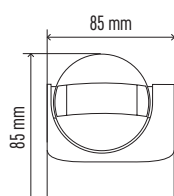

**G1125**

1/-/-/40

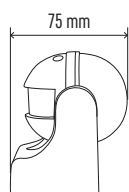
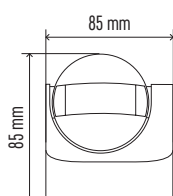

**G1240**

1/-/-/40

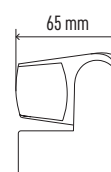
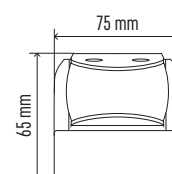

| Type  | EAN           | Detection Angle | Detection Range | Sensor Type | IP Rating | Activation time                   | W × H × D       |
|-------|---------------|-----------------|-----------------|-------------|-----------|-----------------------------------|-----------------|
| G1120 | 8592920032817 | 180°            | 12 m            | PIR         | IP44      | min. 10 seconds – max. 7 minutes  | 85 × 75 × 85 mm |
| G1125 | 8592920032831 | 180°            | 12 m            | PIR         | IP44      | min. 10 seconds – max. 7 minutes  | 85 × 75 × 85 mm |
| G1240 | 8592920085882 | 180°            | 12 m            | PIR         | IP65      | min. 10 seconds – max. 15 minutes | 75 × 65 × 65 mm |

|               |              |
|---------------|--------------|
| Body material | plastic (PC) |
| IP rating     | IP20         |

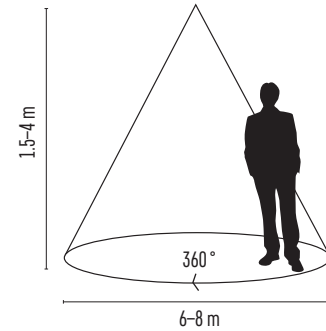

### G1150

1/-/-/20

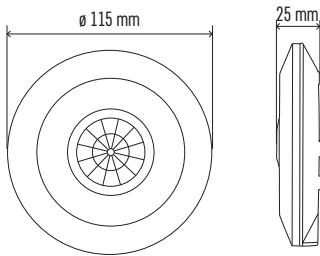

### G1130

1/-/-/20

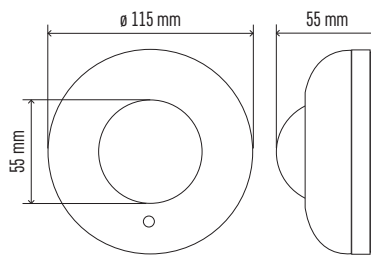

### G1160

1/-/-/36



| Type  | EAN           | Detection Angle | Detection Range | Sensor Type | IP Rating | Activation time                   | Diameter × D  |
|-------|---------------|-----------------|-----------------|-------------|-----------|-----------------------------------|---------------|
| G1150 | 8592920025147 | 360°            | 6 m             | PIR         | IP20      | min. 10 seconds – max. 15 minutes | ø 115 × 25 mm |
| G1130 | 8592920025123 | 360°            | 6 m             | PIR         | IP20      | min. 10 seconds – max. 7 minutes  | ø 115 × 55 mm |
| G1160 | 8592920025154 | 360°            | 6 m             | PIR         | IP20      | min. 10 seconds – max. 15 minutes | ø 70 × 75 mm  |

## LED DRIVERS

|               |              |
|---------------|--------------|
| Body material | plastic (PC) |
| IP rating     | IP20         |

Replacement external power supplies to enable dimming and control. They ensure optimal function, durability and energy efficiency of the luminaire.

### ZZ409BD

1/-/-/48



### ZZ1435T

1/-/-/50



### ZZ2055T

1/-/-/50



### ZZ3070T

1/-/-/50



| Type    | EAN           | Power | Output Current | Output Voltage | Type     | PF    | W × H × D        |
|---------|---------------|-------|----------------|----------------|----------|-------|------------------|
| ZZ409BD | 8592920107102 | 40 W  | 450–1 100 mA   | 6–42 V DC      | DALI 2.0 | > 0.9 | 103 × 68 × 30 mm |
| ZZ1435T | 8592920114322 | 14 W  | 200–350 mA     | 25–40 V DC     | TRIAC    | > 0.9 | 97 × 46 × 31 mm  |
| ZZ2055T | 8592920114339 | 20 W  | 400–550 mA     | 25–40 V DC     | TRIAC    | > 0.9 | 117 × 46 × 31 mm |
| ZZ3070T | 8592920114346 | 28 W  | 550–700 mA     | 25–40 V DC     | TRIAC    | > 0.9 | 117 × 46 × 31 mm |



# Light sources

## LED TUBES

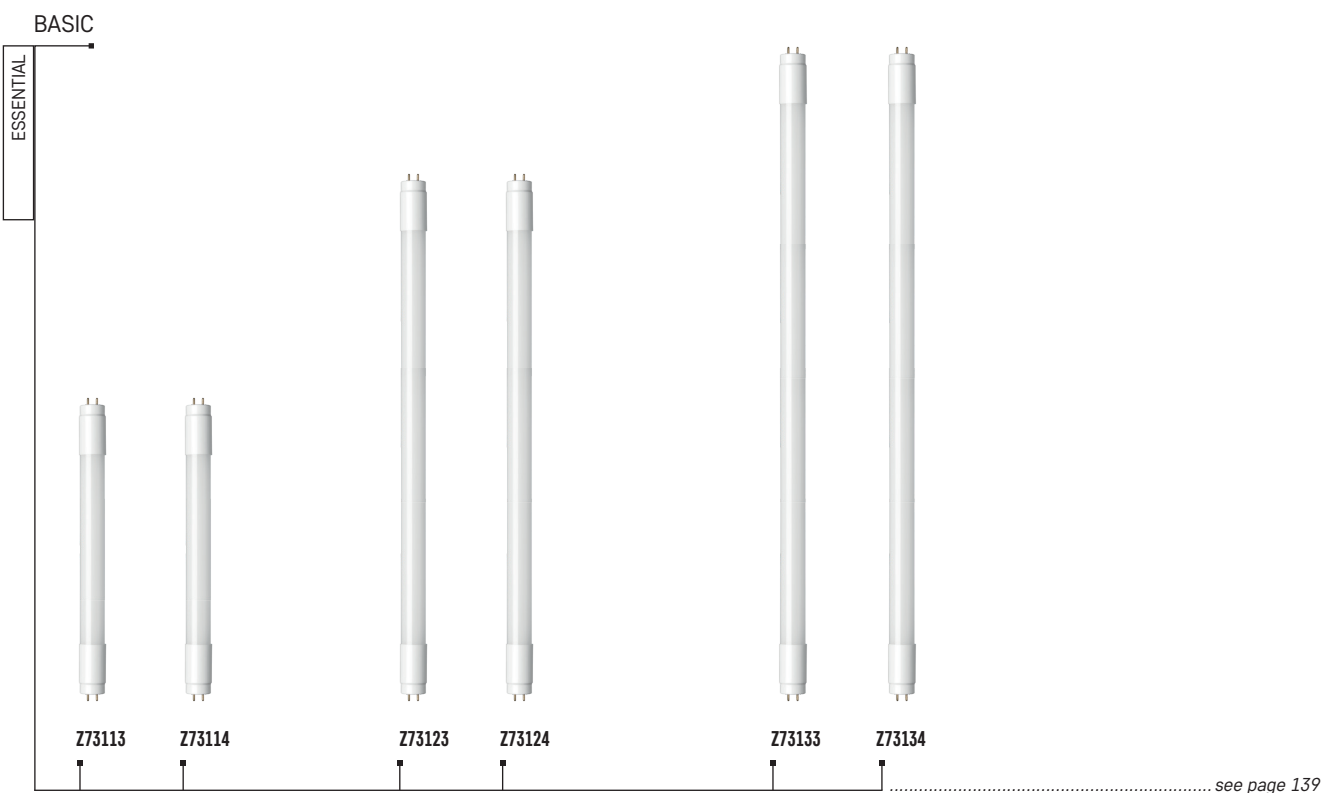
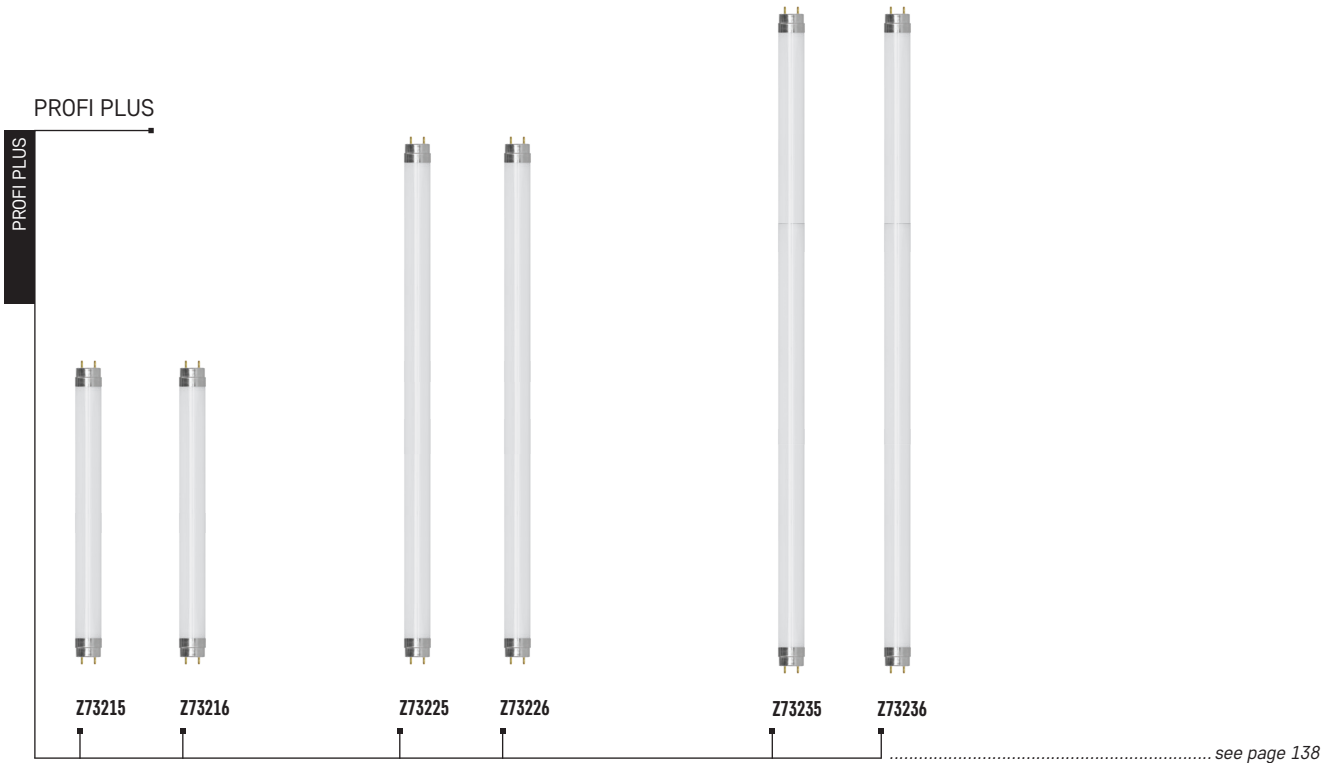

# Light sources

## LIGHT BULBS

### VINTAGE



.....see page 140

### TRUE LIGHT



.....see page 142

### LED FILAMENT A-CLASS



.....see page 143

### LED FILAMENT D-CLASS



.....see page 144–145

LED CLASSIC



# EMOS GoSmart

## GoSmart LED Bulbs

WIFI, ZigBee



## GoSmart LED Strips

WIFI, ZigBee



# PROFI PLUS

PROFI PLUS LED tubes are designed for professional replacement of fluorescent tubes and are characterised by high luminous efficiency up to 151 lm/W.

#### Main benefits:

- high energy saving
- increased durability
- extended warranty 5 years

**Areas of use:** administrative and industrial spaces.

|               |               |
|---------------|---------------|
| Lifetime      | 50 000 hours  |
| CRI           | > 80          |
| Material      | glass+plastic |
| Rotatable cap | no            |
| Lamp base     | G13           |



#### Z73215

10/-/-/10

#### Z73216

10/-/-/10

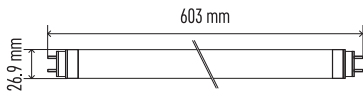

#### Z73225

10/-/-/10

#### Z73226

10/-/-/10

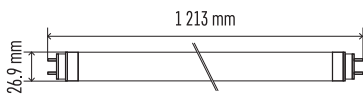

#### Z73235

10/-/-/10

#### Z73236

10/-/-/10

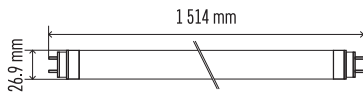

| Type   | EAN           | Power  | Luminous Flux | CCT     | PF  | Luminous Efficacy | Energy Class* | Diameter × D      |
|--------|---------------|--------|---------------|---------|-----|-------------------|---------------|-------------------|
| Z73215 | 8592920104187 | 7.3 W  | 1 100 lm      | 4 000 K | 0.9 | 151 lm/W          | D             | ø 26.9 × 603 mm   |
| Z73216 | 8592920104200 | 7.3 W  | 1 100 lm      | 6 500 K | 0.9 | 151 lm/W          | D             | ø 26.9 × 603 mm   |
| Z73225 | 8592920104224 | 14 W   | 2 100 lm      | 4 000 K | 0.9 | 150 lm/W          | D             | ø 26.9 × 1 213 mm |
| Z73226 | 8592920104248 | 14 W   | 2 100 lm      | 6 500 K | 0.9 | 150 lm/W          | D             | ø 26.9 × 1 213 mm |
| Z73235 | 8592920104262 | 20.6 W | 3 100 lm      | 4 000 K | 0.9 | 150 lm/W          | D             | ø 26.9 × 1 514 mm |
| Z73236 | 8592920104286 | 20.6 W | 3 100 lm      | 6 500 K | 0.9 | 150 lm/W          | D             | ø 26.9 × 1 514 mm |

\* Energy efficiency class on a scale from highest A to lowest G.

# BASIC

BASIC LED tubes are designed to replace conventional fluorescent tubes and are characterised by a luminous efficacy of up to 103 lm/W.

**Main benefits:**

- high energy saving
- long service life
- good value for money

**Areas of use:** administrative and industrial spaces.

|               |              |
|---------------|--------------|
| Lifetime      | 20 000 hours |
| CRI           | > 80         |
| Material      | glass        |
| Rotatable cap | no           |
| Lamp base     | G13          |



**Z73113**

25/-/-/25

**Z73114**

25/-/-/25

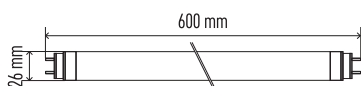

**Z73123**

25/-/-/25

**Z73124**

25/-/-/25

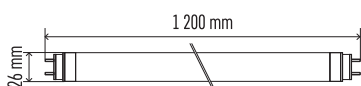

**Z73133**

25/-/-/25

**Z73134**

25/-/-/25

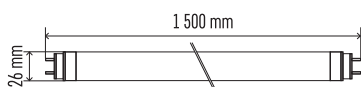

| Type   | EAN           | Power  | Luminous Flux | CCT     | PF  | Luminous Efficacy | Energy Class* | Diameter × D    |
|--------|---------------|--------|---------------|---------|-----|-------------------|---------------|-----------------|
| Z73113 | 8592920115367 | 9.4 W  | 900 lm        | 4 000 K | 0.5 | 96 lm/W           | F             | ø 26 × 600 mm   |
| Z73114 | 8592920115381 | 9.4 W  | 900 lm        | 6 500 K | 0.5 | 96 lm/W           | F             | ø 26 × 600 mm   |
| Z73123 | 8592920115404 | 17.8 W | 1 800 lm      | 4 000 K | 0.5 | 101 lm/W          | F             | ø 26 × 1 200 mm |
| Z73124 | 8592920115428 | 17.8 W | 1 800 lm      | 6 500 K | 0.5 | 101 lm/W          | F             | ø 26 × 1 200 mm |
| Z73133 | 8592920115442 | 24.3 W | 2 500 lm      | 4 000 K | 0.5 | 103 lm/W          | F             | ø 26 × 1 500 mm |
| Z73134 | 8592920115466 | 24.3 W | 2 500 lm      | 6 500 K | 0.5 | 103 lm/W          | F             | ø 26 × 1 500 mm |

\* Energy efficiency class on a scale from highest A to lowest G.

# VINTAGE

Perfect visual replacement for incandescent light bulbs. Create a particularly attractive look when combined with pendant lamp holders.

**Main benefits:**

- attractive design for both modern and old-fashioned luminaires
- replacement for the classic tungsten filament bulb
- energy saving

**Areas of use:** lighting of modern interiors, households and representative areas.



|          |              |
|----------|--------------|
| Lifetime | 25 000 hours |
| CRI      | > 80         |



| Type   | EAN           | Power | Luminous Flux | CCT     | Lamp base | Equivalent Power | Luminous Efficacy | Dimmable | Energy Class* | Packaging | Photo    |
|--------|---------------|-------|---------------|---------|-----------|------------------|-------------------|----------|---------------|-----------|----------|
| Z74300 | 8592920035665 | 2.1 W | 190 lm        | 2 200 K | E14       | 20 W             | 90 lm/W           | no       | F             | 1/-/10/40 | <b>1</b> |
| Z74302 | 8592920035726 | 4 W   | 470 lm        | 2 200 K | E27       | 40 W             | 118 lm/W          | no       | E             | 1/-/10/40 | <b>2</b> |
| Z74303 | 8592920035757 | 4 W   | 470 lm        | 2 200 K | E27       | 40 W             | 118 lm/W          | no       | E             | 1/-/8     | <b>3</b> |
| Z74304 | 8592920035788 | 4 W   | 470 lm        | 2 200 K | E27       | 40 W             | 118 lm/W          | no       | E             | 1/-/8     | <b>5</b> |
| Z74301 | 8592920035696 | 4.3 W | 400 lm        | 2 200 K | E27       | 35 W             | 93 lm/W           | no       | F             | 1/-/10/40 | <b>4</b> |

\* Energy efficiency class on a scale from highest A to lowest G.

**EMOS®**

A brand of **legrand**



# TRUE LIGHT

TRUE LIGHT LED bulbs offer a unique combination of features to support a healthy lifestyle. Reduced amount of blue light component and high colour fidelity in combination with the selected light colour temperature contribute to better concentration and promote healthy sleep.

### Main benefits:

- reduced blue light component
- thanks to the Bridgelux Thrive™ LED chip
- excellent light quality - CRI > 94
- high luminous efficacy > 112 lm/W
- support a healthy lifestyle



|          |              |
|----------|--------------|
| Lifetime | 30 000 hours |
| CRI      | > 94         |



### Light colour neutral white

Reduced emission of the blue light component of TRUE LIGHT bulbs in combination with the neutral white colour positively influences the production of serotonin, or the happiness hormone. This influences our thinking, creativity, performance and ability to concentrate.

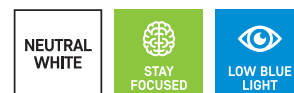

**Areas of use:** Study, children's room, kitchen, etc.

| Type     | EAN           | Power | Luminous Flux | CCT     | Lamp base | Equivalent Power | Luminous Efficacy | Dimmable | Energy Class* | Packaging  | Photo |
|----------|---------------|-------|---------------|---------|-----------|------------------|-------------------|----------|---------------|------------|-------|
| ZQ3225   | 8592920106495 | 4.2 W | 470 lm        | 4 000 K | E14       | 40 W             | 112 lm/W          | no       | E             | 1/-/10/60  | 1     |
| ZQ1226   | 8592920106556 | 4.2 W | 470 lm        | 4 000 K | E14       | 40 W             | 112 lm/W          | no       | E             | 1/-/10/100 | 2     |
| ZQ8356   | 8592920106617 | 4.8 W | 450 lm        | 4 000 K | GU10      | 47 W             | 110 lm/W          | no       | E             | 1/-/10/100 | 4     |
| ZQ5145   | 8592920106402 | 7.2 W | 806 lm        | 4 000 K | E27       | 60 W             | 112 lm/W          | no       | E             | 1/-/10/80  | 3     |
| ZQ5145.3 | 8592920106433 | 7.2 W | 806 lm        | 4 000 K | E27       | 60 W             | 112 lm/W          | no       | E             | 3/-/12/72  | 3     |

### Light colour warm white

The warm white light colour of TRUE LIGHT bulbs is perfect for places where you want to relax, read or unwind after a busy day. Thanks to the reduced blue component of the light, they contribute to the production of melatonin and you will fall asleep easily and then sleep soundly and uninterruptedly until the morning.



**Areas of use:** Bedroom, conservatory, living room, etc.

| Type     | EAN           | Power | Luminous Flux | CCT     | Lamp base | Equivalent Power | Luminous Efficacy | Dimmable | Energy Class* | Packaging  | Photo |
|----------|---------------|-------|---------------|---------|-----------|------------------|-------------------|----------|---------------|------------|-------|
| ZQ3224   | 8592920106464 | 4.2 W | 470 lm        | 2 700 K | E14       | 40 W             | 112 lm/W          | no       | E             | 1/-/10/60  | 1     |
| ZQ1225   | 8592920106525 | 4.2 W | 470 lm        | 2 700 K | E14       | 40 W             | 112 lm/W          | no       | E             | 1/-/10/100 | 2     |
| ZQ8355   | 8592920106587 | 4.8 W | 450 lm        | 2 700 K | GU10      | 47 W             | 110 lm/W          | no       | E             | 1/-/10/100 | 4     |
| ZQ5144   | 8592920106228 | 7.2 W | 806 lm        | 2 700 K | E27       | 60 W             | 112 lm/W          | no       | E             | 1/-/10/80  | 3     |
| ZQ5144.3 | 8592920106372 | 7.2 W | 806 lm        | 2 700 K | E27       | 60 W             | 112 lm/W          | no       | E             | 3/-/12/72  | 3     |



# LED FILAMENT A-CLASS

ULTRA EFFICIENT filament bulbs are a premium range of bulbs in energy class A. They offer an excellent luminous efficiency of 212 lm/W and act as a perfect replacement for tungsten filament bulbs.

**Main benefits:**

- high luminous efficiency of up to 212 lm/W
- significant energy saving up to 60 %
- replacement for conventional tungsten filament bulb

**Areas of use:** lighting of modern interiors, households and representative areas.



1

|          |              |
|----------|--------------|
| Lifetime | 50 000 hours |
| CRI      | > 80         |



| Type     | EAN           | Power | Luminous Flux | CCT     | Lamp base | Equivalent Power | Luminous Efficacy | Dimmable | Energy Class* | Packaging | Photo    |
|----------|---------------|-------|---------------|---------|-----------|------------------|-------------------|----------|---------------|-----------|----------|
| ZF5147   | 8592920120569 | 3.8 W | 806 lm        | 2 700 K | E27       | 60 W             | 212 lm/W          | no       | A             | 1/-/10/40 | <b>1</b> |
| ZF5147.3 | 8592920120590 | 3.8 W | 806 lm        | 2 700 K | E27       | 60 W             | 212 lm/W          | no       | A             | 3/-/12/48 | <b>1</b> |
| ZF5148   | 8592920120620 | 3.8 W | 806 lm        | 4 000 K | E27       | 60 W             | 212 lm/W          | no       | A             | 1/-/10/40 | <b>1</b> |
| ZF5148.3 | 8592920120651 | 3.8 W | 806 lm        | 4 000 K | E27       | 60 W             | 212 lm/W          | no       | A             | 3/-/12/48 | <b>1</b> |
| ZF5157   | 8592920120682 | 5 W   | 1 060 lm      | 2 700 K | E27       | 75 W             | 212 lm/W          | no       | A             | 1/-/10/40 | <b>1</b> |
| ZF5157.3 | 8592920120712 | 5 W   | 1 060 lm      | 2 700 K | E27       | 75 W             | 212 lm/W          | no       | A             | 3/-/12/48 | <b>1</b> |
| ZF5158   | 8592920120743 | 5 W   | 1 060 lm      | 4 000 K | E27       | 75 W             | 212 lm/W          | no       | A             | 1/-/10/40 | <b>1</b> |
| ZF5158.3 | 8592920120774 | 5 W   | 1 060 lm      | 4 000 K | E27       | 75 W             | 212 lm/W          | no       | A             | 3/-/12/48 | <b>1</b> |

\* Energy efficiency class on a scale from highest A to lowest G.

# LED FILAMENT D-CLASS

Filament bulbs are the best, available in the LED bulb market today. They offer maximum luminous efficiency and act as the perfect replacement for tungsten filament bulbs.

**Main benefits:**

- replacement for classic incandescent light bulb
- high luminous efficacy of up to 151 lm/W
- energy savings

|          |              |
|----------|--------------|
| Lifetime | 25 000 hours |
| CRI      | > 80         |



1

| Type     | EAN           | Power | Luminous Flux | CCT     | Lamp base | Equivalent Power | Luminous Efficacy | Dimmable | Energy Class* | Packaging | Photo    |
|----------|---------------|-------|---------------|---------|-----------|------------------|-------------------|----------|---------------|-----------|----------|
| ZF5120   | 8592920114735 | 3.4 W | 470 lm        | 2 700 K | E27       | 40 W             | 138 lm/W          | no       | D             | 1/-/10/20 | <b>1</b> |
| ZF5121   | 8592920114766 | 3.4 W | 470 lm        | 4 000 K | E27       | 40 W             | 138 lm/W          | no       | D             | 1/-/10/20 | <b>1</b> |
| ZF5140   | 8592920114797 | 5.9 W | 806 lm        | 2 700 K | E27       | 60 W             | 137 lm/W          | no       | D             | 1/-/10/20 | <b>1</b> |
| ZF5140.2 | 8592920114827 | 5.9 W | 806 lm        | 2 700 K | E27       | 60 W             | 137 lm/W          | no       | D             | 2/-/6/24  | <b>1</b> |
| ZF5141   | 8592920114858 | 5.9 W | 806 lm        | 4 000 K | E27       | 60 W             | 137 lm/W          | no       | D             | 1/-/10/20 | <b>1</b> |
| Z74270   | 8592920030585 | 7 W   | 1 060 lm      | 2 700 K | E27       | 75 W             | 151 lm/W          | no       | D             | 1/-/10/40 | <b>1</b> |
| Z74271   | 8592920044278 | 7 W   | 1 060 lm      | 4 000 K | E27       | 75 W             | 151 lm/W          | no       | D             | 1/-/10/40 | <b>1</b> |
| Z742700  | 8592920066782 | 8.5 W | 1 055 lm      | 2 700 K | E27       | 75 W             | 124 lm/W          | yes      | E             | 1/-/10/40 | <b>1</b> |



2



| Type   | EAN           | Power | Luminous Flux | CCT     | Lamp base | Equivalent Power | Luminous Efficacy | Dimmable | Energy Class* | Packaging | Photo    |
|--------|---------------|-------|---------------|---------|-----------|------------------|-------------------|----------|---------------|-----------|----------|
| Z74285 | 8592920103548 | 11 W  | 1 521 lm      | 4 000 K | E27       | 100 W            | 138 lm/W          | no       | D             | 1/-/10/30 | <b>2</b> |
| Z74284 | 8592920103517 | 11 W  | 1 521 lm      | 2 700 K | E27       | 100 W            | 138 lm/W          | no       | D             | 1/-/10/30 | <b>2</b> |
| Z74290 | 8592920088029 | 17 W  | 2 452 lm      | 2 700 K | E27       | 150 W            | 144 lm/W          | no       | D             | 1/-/10/30 | <b>2</b> |
| Z74291 | 8592920088050 | 17 W  | 2 452 lm      | 4 000 K | E27       | 150 W            | 144 lm/W          | no       | D             | 1/-/10/30 | <b>2</b> |



3



| Type   | EAN           | Power | Luminous Flux | CCT     | Lamp base | Equivalent Power | Luminous Efficacy | Dimmable | Energy Class* | Packaging | Photo    |
|--------|---------------|-------|---------------|---------|-----------|------------------|-------------------|----------|---------------|-----------|----------|
| ZF3200 | 8592920114919 | 1.8 W | 250 lm        | 2 700 K | E14       | 25 W             | 139 lm/W          | no       | D             | 1/-/10/60 | <b>3</b> |
| ZF3201 | 8592920114940 | 1.8 W | 250 lm        | 4 000 K | E14       | 25 W             | 139 lm/W          | no       | D             | 1/-/10/60 | <b>3</b> |
| ZF3220 | 8592920114971 | 3.4 W | 470 lm        | 2 700 K | E14       | 40 W             | 138 lm/W          | no       | D             | 1/-/10/60 | <b>3</b> |
| ZF3221 | 8592920115008 | 3.4 W | 470 lm        | 4 000 K | E14       | 40 W             | 138 lm/W          | no       | D             | 1/-/10/60 | <b>3</b> |
| ZF3240 | 8592920114551 | 6 W   | 810 lm        | 2 700 K | E14       | 60 W             | 135 lm/W          | no       | D             | 1/-/10/60 | <b>3</b> |
| ZF3241 | 8592920114582 | 6 W   | 810 lm        | 4 000 K | E14       | 60 W             | 135 lm/W          | no       | D             | 1/-/10/60 | <b>3</b> |



4



| Type   | EAN           | Power | Luminous Flux | CCT     | Lamp base | Equivalent Power | Luminous Efficacy | Dimmable | Energy Class* | Packaging  | Photo    |
|--------|---------------|-------|---------------|---------|-----------|------------------|-------------------|----------|---------------|------------|----------|
| ZF1200 | 8592920115060 | 1.8 W | 250 lm        | 2 700 K | E14       | 25 W             | 139 lm/W          | no       | D             | 1/-/10/60  | <b>4</b> |
| ZF1201 | 8592920115091 | 1.8 W | 250 lm        | 4 000 K | E14       | 25 W             | 139 lm/W          | no       | D             | 1/-/10/60  | <b>4</b> |
| ZF1220 | 8592920115114 | 3.4 W | 470 lm        | 2 700 K | E14       | 40 W             | 138 lm/W          | no       | D             | 1/-/10/60  | <b>4</b> |
| ZF1221 | 8592920115145 | 3.4 W | 470 lm        | 4 000 K | E14       | 40 W             | 138 lm/W          | no       | D             | 1/-/10/60  | <b>4</b> |
| ZF1240 | 8592920114612 | 6 W   | 810 lm        | 2 700 K | E14       | 60 W             | 135 lm/W          | no       | D             | 1/-/10/100 | <b>4</b> |
| ZF1241 | 8592920114643 | 6 W   | 810 lm        | 4 000 K | E14       | 60 W             | 135 lm/W          | no       | D             | 1/-/10/100 | <b>4</b> |



5



| Type   | EAN           | Power | Luminous Flux | CCT     | Lamp base | Equivalent Power | Luminous Efficacy | Dimmable | Energy Class* | Packaging  | Photo    |
|--------|---------------|-------|---------------|---------|-----------|------------------|-------------------|----------|---------------|------------|----------|
| ZF1100 | 8592920115206 | 1.8 W | 250 lm        | 2 700 K | E27       | 25 W             | 139 lm/W          | no       | D             | 1/-/10/60  | <b>5</b> |
| ZF1101 | 8592920115237 | 1.8 W | 250 lm        | 4 000 K | E27       | 25 W             | 139 lm/W          | no       | D             | 1/-/10/60  | <b>5</b> |
| ZF1120 | 8592920115268 | 3.4 W | 470 lm        | 2 700 K | E27       | 40 W             | 138 lm/W          | no       | D             | 1/-/10/60  | <b>5</b> |
| ZF1121 | 8592920115299 | 3.4 W | 470 lm        | 4 000 K | E27       | 40 W             | 138 lm/W          | no       | D             | 1/-/10/60  | <b>5</b> |
| ZF1140 | 8592920114674 | 6 W   | 810 lm        | 2 700 K | E27       | 60 W             | 135 lm/W          | no       | D             | 1/-/10/100 | <b>5</b> |
| ZF1141 | 8592920114704 | 6 W   | 810 lm        | 4 000 K | E27       | 60 W             | 135 lm/W          | no       | D             | 1/-/10/100 | <b>5</b> |



6



7



8



9



| Type   | EAN           | Power | Luminous Flux | CCT     | Lamp base | Equivalent Power | Luminous Efficacy | Dimmable | Energy Class* | Packaging | Photo    |
|--------|---------------|-------|---------------|---------|-----------|------------------|-------------------|----------|---------------|-----------|----------|
| ZF6140 | 8592920114889 | 5.9 W | 806 lm        | 2 700 K | E27       | 60 W             | 137 lm/W          | no       | D             | 1/-/10/20 | <b>6</b> |
| ZF4220 | 8592920115039 | 3.4 W | 470 lm        | 2 700 K | E14       | 40 W             | 138 lm/W          | no       | D             | 1/-/10/60 | <b>7</b> |
| ZF7220 | 8592920115176 | 3.4 W | 470 lm        | 2 700 K | E14       | 40 W             | 138 lm/W          | no       | D             | 1/-/10/60 | <b>8</b> |
| ZF7120 | 8592920115329 | 3.4 W | 470 lm        | 2 700 K | E27       | 40 W             | 138 lm/W          | no       | D             | 1/-/10/60 | <b>9</b> |



9



| Type   | EAN           | Power | Luminous Flux | CCT     | Lamp base | Equivalent Power | Luminous Efficacy | Dimmable | Energy Class* | Packaging | Photo     |
|--------|---------------|-------|---------------|---------|-----------|------------------|-------------------|----------|---------------|-----------|-----------|
| ZF2150 | 8592920116982 | 7.8 W | 1 055 lm      | 2 700 K | E27       | 75 W             | 135 lm/W          | no       | D             | 1/-/4/8   | <b>10</b> |
| ZF2151 | 8592920117019 | 7.8 W | 1 055 lm      | 4 000 K | E27       | 75 W             | 135 lm/W          | no       | D             | 1/-/4/8   | <b>10</b> |
| ZF2160 | 8592920117040 | 11 W  | 1 521 lm      | 2 700 K | E27       | 100 W            | 138 lm/W          | no       | D             | 1/-/4/8   | <b>10</b> |
| ZF2161 | 8592920117071 | 11 W  | 1 521 lm      | 4 000 K | E27       | 100 W            | 138 lm/W          | no       | D             | 1/-/4/8   | <b>10</b> |
| ZF2180 | 8592920117101 | 18 W  | 2 452 lm      | 2 700 K | E27       | 150 W            | 136 lm/W          | no       | D             | 1/-/4/8   | <b>10</b> |
| ZF2181 | 8592920117132 | 18 W  | 2 452 lm      | 4 000 K | E27       | 150 W            | 136 lm/W          | no       | D             | 1/-/4/8   | <b>10</b> |

\* Energy efficiency class on a scale from highest A to lowest G.

# LED CLASSIC

CLASSIC LED bulbs are an economical light source with an optimal price/quality ratio. They are powerful, economical and have an extremely long lifetime. Thanks to their low consumption, they bring these bulbs save up to 90% energy compared to conventional bulbs.

**Main benefits:**

- low energy consumption
- long lifetime, high luminous efficiency
- optimal for frequent switching on and off
- environmentally friendly

**Areas of use:** lighting of modern interiors, homes and representative spaces.











|          |              |
|----------|--------------|
| Lifetime | 30 000 hours |
| CRI      | > 80         |







| Type     | EAN           | Power  | Luminous Flux | CCT     | Lamp base | Equivalent Power | Luminous Efficacy | Dimmable | Energy Class* | Packaging | Photo |
|----------|---------------|--------|---------------|---------|-----------|------------------|-------------------|----------|---------------|-----------|-------|
| Z05120   | 8592920080757 | 5.2 W  | 470 lm        | 2 700 K | E27       | 40 W             | 90 lm/W           | no       | F             | 1/-/10/40 | 1     |
| Z05121   | 8592920080788 | 5.2 W  | 470 lm        | 4 000 K | E27       | 40 W             | 90 lm/W           | no       | F             | 1/-/10/40 | 1     |
| Z05130   | 8592920044391 | 7.3 W  | 645 lm        | 2 700 K | E27       | 50 W             | 88 lm/W           | no       | F             | 1/-/10/80 | 1     |
| Z05131   | 8592920044421 | 7.3 W  | 645 lm        | 4 000 K | E27       | 50 W             | 88 lm/W           | no       | F             | 1/-/10/80 | 1     |
| Z05140   | 8592920044452 | 8.5 W  | 806 lm        | 2 700 K | E27       | 60 W             | 95 lm/W           | no       | F             | 1/-/10/40 | 1     |
| Z05140.6 | 8592920054970 | 8.5 W  | 806 lm        | 2 700 K | E27       | 60 W             | 95 lm/W           | no       | F             | 6/-/72    | 1     |
| Z05141   | 8592920044513 | 8.5 W  | 806 lm        | 4 000 K | E27       | 60 W             | 95 lm/W           | no       | F             | 1/-/10/40 | 1     |
| Z05141.6 | 8592920076071 | 8.5 W  | 806 lm        | 4 000 K | E27       | 60 W             | 95 lm/W           | no       | F             | 6/-/72    | 1     |
| Z05142   | 8592920044568 | 8.5 W  | 806 lm        | 6 500 K | E27       | 60 W             | 95 lm/W           | no       | F             | 1/-/10/40 | 1     |
| Z05140.3 | 8592920044483 | 8.5 W  | 806 lm        | 2 700 K | E27       | 60 W             | 95 lm/W           | no       | F             | 3/-/12/72 | 1     |
| Z05141.3 | 8592920053737 | 8.5 W  | 806 lm        | 4 000 K | E27       | 60 W             | 95 lm/W           | no       | F             | 3/-/12/72 | 1     |
| ZL4206   | 8592920044360 | 10.5 W | 1 060 lm      | 2 700 K | E27       | 75 W             | 101 lm/W          | yes      | F             | 1/-/10/80 | 1     |
| Z05150   | 8592920044681 | 10.7 W | 1 060 lm      | 2 700 K | E27       | 75 W             | 99 lm/W           | no       | F             | 1/-/10/40 | 2     |
| Z05150.3 | 8592920064801 | 10.7 W | 1 060 lm      | 2 700 K | E27       | 75 W             | 99 lm/W           | no       | F             | 3/-/12/48 | 2     |
| Z05151   | 8592920044711 | 10.7 W | 1 060 lm      | 4 000 K | E27       | 75 W             | 99 lm/W           | no       | F             | 1/-/10/40 | 2     |
| Z05151.3 | 8592920064832 | 10.7 W | 1 060 lm      | 4 000 K | E27       | 75 W             | 99 lm/W           | no       | F             | 3/-/12/48 | 2     |
| Z05152   | 8592920044742 | 10.7 W | 1 060 lm      | 6 500 K | E27       | 75 W             | 99 lm/W           | no       | F             | 1/-/10/40 | 2     |
| Z05160   | 8592920044773 | 13.2 W | 1 521 lm      | 2 700 K | E27       | 100 W            | 115 lm/W          | no       | E             | 1/-/10/40 | 2     |
| Z05160.3 | 8592920079942 | 13.2 W | 1 521 lm      | 2 700 K | E27       | 100 W            | 115 lm/W          | no       | E             | 3/-/12/48 | 2     |
| Z05161   | 8592920044803 | 13.2 W | 1 521 lm      | 4 000 K | E27       | 100 W            | 115 lm/W          | no       | E             | 1/-/10/40 | 2     |
| Z05161.3 | 8592920079973 | 13.2 W | 1 521 lm      | 4 000 K | E27       | 100 W            | 115 lm/W          | no       | E             | 3/-/12/48 | 2     |
| Z05162   | 8592920064276 | 13.2 W | 1 521 lm      | 6 500 K | E27       | 100 W            | 115 lm/W          | no       | E             | 1/-/10/40 | 2     |
| Z05173   | 8592920110386 | 17 W   | 1 900 lm      | 2 700 K | E27       | 120 W            | 112 lm/W          | no       | E             | 1/-/10/40 | 3     |
| Z05174   | 8592920110416 | 17 W   | 1 900 lm      | 4 000 K | E27       | 120 W            | 112 lm/W          | no       | E             | 1/-/10/40 | 3     |
| Z05175   | 8592920110447 | 17 W   | 1 900 lm      | 6 500 K | E27       | 120 W            | 112 lm/W          | no       | E             | 1/-/10/40 | 3     |
| Z05183   | 8592920110478 | 19 W   | 2 452 lm      | 2 700 K | E27       | 150 W            | 129 lm/W          | no       | E             | 1/-/10/40 | 3     |
| Z05184   | 8592920110508 | 19 W   | 2 452 lm      | 4 000 K | E27       | 150 W            | 129 lm/W          | no       | E             | 1/-/10/40 | 3     |
| Z05185   | 8592920110539 | 19 W   | 2 452 lm      | 6 500 K | E27       | 150 W            | 129 lm/W          | no       | E             | 1/-/10/40 | 3     |

\* Energy efficiency class on a scale from highest A to lowest G.













| Type     | EAN           | Power | Luminous Flux | CCT     | Lamp base | Equivalent Power | Luminous Efficacy | Dimmable | Energy Class* | Packaging | Photo   |
|----------|---------------|-------|---------------|---------|-----------|------------------|-------------------|----------|---------------|-----------|---|
| ZQ3210   | 8592920044988 | 4.1 W | 350 lm        | 2 700 K | E14       | 32 W             | 85 lm/W           | no       | F             | 1/-/10/60 |  |
| ZQ3211   | 8592920045015 | 4.1 W | 350 lm        | 4 000 K | E14       | 32 W             | 85 lm/W           | no       | F             | 1/-/10/60 |  |
| ZQ3220   | 8592920045107 | 5 W   | 470 lm        | 2 700 K | E14       | 40 W             | 94 lm/W           | no       | F             | 1/-/10/60 |  |
| ZQ3221   | 8592920045138 | 5 W   | 470 lm        | 4 000 K | E14       | 40 W             | 94 lm/W           | no       | F             | 1/-/10/60 |  |
| ZQ3222   | 8592920045169 | 5 W   | 470 lm        | 6 500 K | E14       | 40 W             | 94 lm/W           | no       | F             | 1/-/10/60 |  |
| ZQ3220.3 | 8592920064863 | 5 W   | 470 lm        | 2 700 K | E14       | 40 W             | 94 lm/W           | no       | F             | 3/-/30/90 |  |
| ZQ3221.3 | 8592920064894 | 5 W   | 470 lm        | 4 000 K | E14       | 40 W             | 94 lm/W           | no       | F             | 3/-/30/90 |  |
| ZQ3230   | 8592920076330 | 7.3 W | 806 lm        | 2 700 K | E14       | 60 W             | 110 lm/W          | no       | E             | 1/-/10/60 |  |
| ZQ3231   | 8592920076347 | 7.3 W | 806 lm        | 4 000 K | E14       | 60 W             | 110 lm/W          | no       | E             | 1/-/10/60 |  |
| ZQ3232   | 8592920090084 | 7.3 W | 806 lm        | 6 500 K | E14       | 60 W             | 110 lm/W          | no       | E             | 1/-/10/60 |  |













| Type   | EAN           | Power | Luminous Flux | CCT     | Lamp base | Equivalent Power | Luminous Efficacy | Dimmable | Energy Class* | Packaging | Photo   |
|--------|---------------|-------|---------------|---------|-----------|------------------|-------------------|----------|---------------|-----------|---|
| ZQ3120 | 8592920121238 | 4.9 W | 470 lm        | 2 700 K | E27       | 40 W             | 96 lm/W           | no       | F             | 1/-/10/60 |    |
| ZQ3121 | 8592920121269 | 4.9 W | 470 lm        | 4 000 K | E27       | 40 W             | 96 lm/W           | no       | F             | 1/-/10/60 |    |
| ZQ3110 | 8592920045046 | 4.1 W | 350 lm        | 2 700 K | E27       | 32 W             | 85 lm/W           | no       | F             | 1/-/10/60 |   |
| ZQ3111 | 8592920045077 | 4.1 W | 350 lm        | 4 000 K | E27       | 32 W             | 85 lm/W           | no       | F             | 1/-/10/60 |  |



| Type     | EAN           | Power | Luminous Flux | CCT     | Lamp base | Equivalent Power | Luminous Efficacy | Dimmable | Energy Class* | Packaging  | Photo   |
|----------|---------------|-------|---------------|---------|-----------|------------------|-------------------|----------|---------------|------------|---|
| ZQ1210   | 8592920045343 | 4.1 W | 350 lm        | 2 700 K | E14       | 32 W             | 85 lm/W           | no       | F             | 1/-/10/100 |  |
| ZQ1211   | 8592920045374 | 4.1 W | 350 lm        | 4 000 K | E14       | 32 W             | 85 lm/W           | no       | F             | 1/-/10/100 |  |
| ZQ1220   | 8592920045466 | 5 W   | 470 lm        | 2 700 K | E14       | 40 W             | 94 lm/W           | no       | F             | 1/-/10/100 |  |
| ZQ1221   | 8592920045527 | 5 W   | 470 lm        | 4 000 K | E14       | 40 W             | 94 lm/W           | no       | F             | 1/-/10/100 |  |
| ZQ1222   | 8592920045589 | 5 W   | 470 lm        | 6 500 K | E14       | 40 W             | 94 lm/W           | no       | F             | 1/-/10/100 |  |
| ZQ1220.3 | 8592920072349 | 5 W   | 470 lm        | 2 700 K | E14       | 40 W             | 94 lm/W           | no       | F             | 3/-/30/90  |  |
| ZQ1221.3 | 8592920072356 | 5 W   | 470 lm        | 4 000 K | E14       | 40 W             | 94 lm/W           | no       | F             | 3/-/30/90  |  |
| ZQ1230   | 8592920076354 | 7.3 W | 806 lm        | 2 700 K | E14       | 60 W             | 110 lm/W          | no       | E             | 1/-/10/100 |  |
| ZQ1231   | 8592920076361 | 7.3 W | 806 lm        | 4 000 K | E14       | 60 W             | 110 lm/W          | no       | E             | 1/-/10/100 |  |
| ZQ1232   | 8592920090114 | 7.3 W | 806 lm        | 6 500 K | E14       | 60 W             | 110 lm/W          | no       | E             | 1/-/10/100 |  |



| Type     | EAN           | Power | Luminous Flux | CCT     | Lamp base | Equivalent Power | Luminous Efficacy | Dimmable | Energy Class* | Packaging  | Photo   |
|----------|---------------|-------|---------------|---------|-----------|------------------|-------------------|----------|---------------|------------|---|
| ZQ1110   | 8592920045404 | 4.1 W | 350 lm        | 2 700 K | E27       | 32 W             | 85 lm/W           | no       | F             | 1/-/10/100 |  |
| ZQ1111   | 8592920045435 | 4.1 W | 350 lm        | 4 000 K | E27       | 32 W             | 85 lm/W           | no       | F             | 1/-/10/100 |  |
| ZQ1120   | 8592920045497 | 5 W   | 470 lm        | 2 700 K | E27       | 40 W             | 94 lm/W           | no       | F             | 1/-/10/100 |  |
| ZQ1121   | 8592920045558 | 5 W   | 470 lm        | 4 000 K | E27       | 40 W             | 94 lm/W           | no       | F             | 1/-/10/100 |  |
| ZQ1122   | 8592920045619 | 5 W   | 470 lm        | 6 500 K | E27       | 40 W             | 94 lm/W           | no       | F             | 1/-/10/100 |  |
| ZQ1120.3 | 8592920088845 | 5 W   | 470 lm        | 2 700 K | E27       | 40 W             | 94 lm/W           | no       | F             | 3/-/30/90  |  |
| ZQ1121.3 | 8592920088876 | 5 W   | 470 lm        | 4 000 K | E27       | 40 W             | 94 lm/W           | no       | F             | 3/-/30/90  |  |
| ZQ1130   | 8592920076378 | 7.3 W | 806 lm        | 2 700 K | E27       | 60 W             | 110 lm/W          | no       | E             | 1/-/10/100 |  |
| ZQ1131   | 8592920076385 | 7.3 W | 806 lm        | 4 000 K | E27       | 60 W             | 110 lm/W          | no       | E             | 1/-/10/100 |  |
| ZQ1132   | 8592920090145 | 7.3 W | 806 lm        | 6 500 K | E27       | 60 W             | 110 lm/W          | no       | E             | 1/-/10/100 |  |

\* Energy efficiency class on a scale from highest A to lowest G.

# LED CLASSIC

Lifetime 30 000 hours

CRI > 80



1

2



| Type   | EAN           | Power | Luminous Flux | CCT     | Lamp base | Equivalent Power | Luminous Efficacy | Dimmable | Energy Class* | Packaging | Photo |
|--------|---------------|-------|---------------|---------|-----------|------------------|-------------------|----------|---------------|-----------|-------|
| Z07220 | 8592920045794 | 4 W   | 450 lm        | 2 700 K | E14       | 39 W             | 113 lm/W          | no       | E             | 1/-/10/60 | 1     |
| Z07221 | 8592920045824 | 4 W   | 450 lm        | 4 000 K | E14       | 39 W             | 113 lm/W          | no       | E             | 1/-/10/60 | 1     |
| Z07140 | 8592920045855 | 8.8 W | 806 lm        | 2 700 K | E27       | 60 W             | 92 lm/W           | no       | F             | 1/-/10/80 | 2     |
| Z07141 | 8592920045886 | 8.8 W | 806 lm        | 4 000 K | E27       | 60 W             | 92 lm/W           | no       | F             | 1/-/10/80 | 2     |



1

2



| Type     | EAN           | Power | Luminous Flux | CCT     | Lamp base | Equivalent Power | Luminous Efficacy | Dimmable | Energy Class* | Packaging  | Photo |
|----------|---------------|-------|---------------|---------|-----------|------------------|-------------------|----------|---------------|------------|-------|
| Z08340   | 8592920045916 | 3.8 W | 320 lm        | 3 000 K | GU10      | 30 W             | 84 lm/W           | no       | G             | 1/-/10/100 | 1     |
| Z08341   | 8592920045978 | 3.8 W | 320 lm        | 4 000 K | GU10      | 30 W             | 84 lm/W           | no       | G             | 1/-/10/100 | 1     |
| Z08342   | 8592920046005 | 3.8 W | 320 lm        | 6 500 K | GU10      | 30 W             | 84 lm/W           | no       | G             | 1/-/10/100 | 1     |
| Z08340.3 | 8592920045947 | 3.8 W | 320 lm        | 3 000 K | GU10      | 30 W             | 84 lm/W           | no       | G             | 3/-/30/90  | 1     |
| Z08350   | 8592920046036 | 5.7 W | 465 lm        | 3 000 K | GU10      | 40 W             | 82 lm/W           | no       | G             | 1/-/10/100 | 1     |
| Z08351   | 8592920046067 | 5.7 W | 465 lm        | 4 000 K | GU10      | 40 W             | 82 lm/W           | no       | G             | 1/-/10/100 | 1     |
| ZL4301   | 8592920029510 | 6.1 W | 560 lm        | 3 000 K | GU10      | 45 W             | 92 lm/W           | yes      | F             | 1/-/10/100 | 2     |
| Z08370   | 8592920084601 | 8.4 W | 806 lm        | 3 000 K | GU10      | 60 W             | 96 lm/W           | no       | F             | 1/-/10/100 | 1     |
| Z08370.3 | 8592920084748 | 8.4 W | 806 lm        | 3 000 K | GU10      | 60 W             | 96 lm/W           | no       | F             | 3/-/30/90  | 1     |
| Z08371   | 8592920084632 | 8.4 W | 806 lm        | 4 000 K | GU10      | 60 W             | 96 lm/W           | no       | F             | 1/-/10/100 | 1     |
| Z08371.3 | 8592920084779 | 8.4 W | 806 lm        | 4 000 K | GU10      | 60 W             | 96 lm/W           | no       | F             | 3/-/30/90  | 1     |
| Z08372   | 8592920084663 | 8.4 W | 806 lm        | 6 500 K | GU10      | 60 W             | 96 lm/W           | no       | F             | 1/-/10/100 | 1     |



1



| Type   | EAN           | Power | Luminous Flux | CCT     | Lamp base | Equivalent Power | Luminous Efficacy | Dimmable | Energy Class* | Packaging | Photo |
|--------|---------------|-------|---------------|---------|-----------|------------------|-------------------|----------|---------------|-----------|-------|
| Z08333 | 8592920056028 | 4.2 W | 333 lm        | 3 000 K | GU10      | 36 W             | 93 lm/W           | no       | F             | 1/-/10/60 | 1     |
| Z08334 | 8592920056059 | 4.2 W | 333 lm        | 4 000 K | GU10      | 40 W             | 93 lm/W           | no       | F             | 1/-/10/60 | 1     |
| Z08335 | 8592920056080 | 4.2 W | 333 lm        | 6 500 K | GU10      | 39 W             | 93 lm/W           | no       | F             | 1/-/10/60 | 1     |



1



| Type   | EAN           | Power | Luminous Flux | CCT     | Lamp base | Equivalent Power | Luminous Efficacy | Dimmable | Energy Class* | Packaging | Photo |
|--------|---------------|-------|---------------|---------|-----------|------------------|-------------------|----------|---------------|-----------|-------|
| Z08433 | 8592920056110 | 4.5 W | 380 lm        | 3 000 K | GU5.3     | 28 W             | 99 lm/W           | no       | F             | 1/-/10/60 | 1     |
| Z08434 | 8592920056141 | 4.5 W | 380 lm        | 4 000 K | GU5.3     | 31 W             | 99 lm/W           | no       | F             | 1/-/10/60 | 1     |

\* Energy efficiency class on a scale from highest A to lowest G.



1

NEUTRAL WHITE

| Type   | EAN           | Power | Luminous Flux | CCT     | Lamp base | Equivalent Power | Luminous Efficacy | Dimmable | Energy Class* | Packaging  | Photo |
|--------|---------------|-------|---------------|---------|-----------|------------------|-------------------|----------|---------------|------------|-------|
| ZL4780 | 8592920029398 | 7 W   | 580 lm        | 4 000 K | GU10      | 81 W             | 97 lm/W           | no       | F             | 1/-/10/100 | 1     |



1



2



3

WARM WHITE

NEUTRAL WHITE

| Type     | EAN           | Power | Luminous Flux | CCT     | Lamp base | Equivalent Power | Luminous Efficacy | Dimmable | Energy Class* | Packaging  | Photo |
|----------|---------------|-------|---------------|---------|-----------|------------------|-------------------|----------|---------------|------------|-------|
| ZQ9526   | 8592920114490 | 1.9 W | 210 lm        | 3 000 K | G9        | 22 W             | 111 lm/W          | no       | E             | 1/-/10/80  | 1     |
| ZQ9527   | 8592920114520 | 1.9 W | 210 lm        | 4 000 K | G9        | 22 W             | 111 lm/W          | no       | E             | 1/-/10/80  | 1     |
| ZQ9535   | 8592920119006 | 2.5 W | 350 lm        | 3 000 K | G9        | 32 W             | 140 lm/W          | no       | D             | 1/-/10/80  | 2     |
| ZQ9536   | 8592920119037 | 2.5 W | 350 lm        | 4 000 K | G9        | 32 W             | 140 lm/W          | no       | D             | 1/-/10/80  | 2     |
| ZQ9544   | 8592920119068 | 4 W   | 470 lm        | 3 000 K | G9        | 40 W             | 118 lm/W          | no       | E             | 1/-/10/80  | 3     |
| ZQ9545   | 8592920119099 | 4 W   | 470 lm        | 4 000 K | G9        | 40 W             | 118 lm/W          | no       | E             | 1/-/10/80  | 3     |
| ZQ9544.2 | 8592920119129 | 4 W   | 470 lm        | 3 000 K | G9        | 40 W             | 118 lm/W          | no       | E             | 2/-/20/160 | 3     |
| ZQ9545.2 | 8592920119150 | 4 W   | 470 lm        | 4 000 K | G9        | 40 W             | 118 lm/W          | no       | E             | 2/-/20/160 | 3     |



1

WARM WHITE

NEUTRAL WHITE

| Type     | EAN           | Power | Luminous Flux | CCT     | Lamp base | Equivalent Power | Luminous Efficacy | Dimmable | Energy Class* | Packaging  | Photo |
|----------|---------------|-------|---------------|---------|-----------|------------------|-------------------|----------|---------------|------------|-------|
| ZQ8620   | 8592920046661 | 1.9 W | 200 lm        | 3 000 K | G4        | 21 W             | 97 lm/W           | no       | F             | 1/-/10/120 | 1     |
| ZQ8621   | 8592920046692 | 1.9 W | 200 lm        | 4 000 K | G4        | 21 W             | 97 lm/W           | no       | F             | 1/-/10/120 | 1     |
| ZQ8620.2 | 8592920122983 | 1.9 W | 200 lm        | 3 000 K | G4        | 21 W             | 97 lm/W           | no       | F             | 2/-/20/120 | 1     |
| ZQ8621.2 | 8592920123010 | 1.9 W | 200 lm        | 4 000 K | G4        | 21 W             | 97 lm/W           | no       | F             | 2/-/20/120 | 1     |



1

WARM WHITE

NEUTRAL WHITE

| Type   | EAN           | Power | Luminous Flux | CCT     | Lamp base | Equivalent Power | Luminous Efficacy | Dimmable | Energy Class* | Packaging | Photo |
|--------|---------------|-------|---------------|---------|-----------|------------------|-------------------|----------|---------------|-----------|-------|
| ZQ9140 | 8592920068359 | 4.5 W | 465 lm        | 3 000 K | E14       | 40 W             | 103 lm/W          | no       | F             | 1/-/10/60 | 1     |
| ZQ9141 | 8592920068380 | 4.5 W | 465 lm        | 4 000 K | E14       | 40 W             | 103 lm/W          | no       | F             | 1/-/10/60 | 1     |



1

NEUTRAL WHITE

| Type   | EAN           | Power  | Luminous Flux | CCT     | Lamp base | Equivalent Power | Luminous Efficacy | Dimmable | Energy Class* | Packaging | Photo |
|--------|---------------|--------|---------------|---------|-----------|------------------|-------------------|----------|---------------|-----------|-------|
| ZL5751 | 8592920058572 | 44.5 W | 4 850 lm      | 4 000 K | E27       | 270 W            | 109 lm/W          | no       | F             | 1/-/8     | 1     |



1

NEUTRAL WHITE

| Type  | EAN           | Power | Luminous Flux | CCT     | Lamp base | Equivalent Power | Luminous Efficacy | Dimmable | Energy Class* | Packaging  | Photo |
|-------|---------------|-------|---------------|---------|-----------|------------------|-------------------|----------|---------------|------------|-------|
| Z6913 | 8592920064399 | 1.8 W | 160 lm        | 4 000 K | E14       | 17 W             | 89 lm/W           | no       | F             | 1/-/10/100 | 1     |

\* Energy efficiency class on a scale from highest A to lowest G.

# GoSmart WIFI

EMOS GoSmart bulbs with WIFI technology are intelligent lighting that can be controlled with a mobile app. The bulbs allow pairing into groups and different properties setting, such as colour and light intensity as desired.

**Main benefits:**

- mobile phone app control
- option to pair multiple bulbs into groups
- dimming and RGB colour changing
- true-to-life RGB colour display

**Areas of use:** lighting of modern interiors, households and representative areas.

|          |              |
|----------|--------------|
| Lifetime | 20 000 hours |
| CRI      | > 80         |



EMOS GoSmart



| Type    | EAN           | Power | Luminous Flux | CCT           | Lamp base | Equivalent Power | Luminous Efficacy | Dimmable | Energy Class* | Packaging | Photo |
|---------|---------------|-------|---------------|---------------|-----------|------------------|-------------------|----------|---------------|-----------|-------|
| ZQW514R | 8592920120125 | 9 W   | 806 lm        | 2 700–6 500 K | E27       | 60 W             | 90 lm/W           | yes      | F             | 1/-/10/40 | 1     |
| ZQW515R | 8592920120156 | 11 W  | 1 050 lm      | 2 700–6 500 K | E27       | 75 W             | 95 lm/W           | yes      | F             | 1/-/10/40 | 1     |
| ZQW516R | 8592920120187 | 14 W  | 1 400 lm      | 2 700–6 500 K | E27       | 94 W             | 100 lm/W          | yes      | F             | 1/-/10/40 | 1     |
| ZQW322R | 8592920120217 | 4.8 W | 470 lm        | 2 700–6 500 K | E14       | 40 W             | 98 lm/W           | yes      | F             | 1/-/10/60 | 2     |
| ZQW832R | 8592920120248 | 4.8 W | 400 lm        | 2 700–6 500 K | GU10      | 35 W             | 83 lm/W           | yes      | G             | 1/-/10/90 | 3     |

\* Energy efficiency class on a scale from highest A to lowest G.



## GoSmart ZigBee

EMOS GoSmart bulbs with ZigBee technology are an excellent solution for the smart home lighting. The bulbs are controlled and connected to the home WIFI network via a ZigBee gateway and mobile app. With dimming and colour changing options, it's easy to create the ideal room atmosphere based on your preferences.

### Main benefits:

- mobile phone app control
- option to pair multiple bulbs into groups
- dimming and RGB colour changing
- true-to-life RGB colour display

**Areas of use:** lighting of modern interiors, households and representative areas.



EMOS GoSmart



ZigBee

3.0



|          |              |
|----------|--------------|
| Lifetime | 20 000 hours |
| CRI      | > 80         |



| Type    | EAN           | Power | Luminous Flux | CCT           | Lamp base | Equivalent Power | Luminous Efficacy | Dimmable | Energy Class* | Packaging | Photo |
|---------|---------------|-------|---------------|---------------|-----------|------------------|-------------------|----------|---------------|-----------|-------|
| Z0Z514R | 8592920121078 | 9 W   | 806 lm        | 2 700-6 500 K | E27       | 60 W             | 90 lm/W           | yes      | F             | 1/-/10/40 | 1     |
| Z0Z515R | 8592920121108 | 11 W  | 1 050 lm      | 2 700-6 500 K | E27       | 75 W             | 95 lm/W           | yes      | F             | 1/-/10/40 | 1     |
| Z0Z516R | 8592920121139 | 14 W  | 1 400 lm      | 2 700-6 500 K | E27       | 94 W             | 100 lm/W          | yes      | F             | 1/-/10/40 | 1     |
| Z0Z322R | 8592920121160 | 4.8 W | 470 lm        | 2 700-6 500 K | E14       | 40 W             | 98 lm/W           | yes      | F             | 1/-/10/60 | 2     |
| Z0Z832R | 8592920121191 | 4.8 W | 400 lm        | 2 700-6 500 K | GU10      | 35 W             | 83 lm/W           | yes      | G             | 1/-/10/90 | 3     |

\* Energy efficiency class on a scale from highest A to lowest G.

# GoSmart WIFI

EMOS GoSmart LED strips with WIFI technology bring the right brightness and colour to your interior. Thanks to the mobile app, control is always at your fingertips. The LED strips are an excellent solution for both illuminating the entire room and highlighting aesthetic elements.

**Main benefits:**

- mobile phone app control
- dimming and RGB colour changing option

**Areas of use:** lighting of modern interiors, households and representative areas.

|          |                              |
|----------|------------------------------|
| Lifetime | 15 000 hours<br>20 000 hours |
| CRI      | > 80                         |

**NEW** **3 YEARS WARRANTY** **A ↑ G**



**DIMMABLE** 10% - 100% **CCT** **RGB**

| Type    | EAN           | Power | Luminous Flux | CCT           | Length | Luminous Efficacy | Dimmable | Energy Class* | Packaging | Photo    |
|---------|---------------|-------|---------------|---------------|--------|-------------------|----------|---------------|-----------|----------|
| ZPW218R | 8592920120446 | 11 W  | 450 lm        | 3 000-6 500 K | 2 m    | 38 lm/W           | yes      | G             | 1/-/-/10  | <b>1</b> |
| ZPW252R | 8592920120484 | 18 W  | 1 400 lm      | 3 000-6 500 K | 2 m    | 72 lm/W           | yes      | G             | 1/-/-/10  | <b>1</b> |
| ZPW518R | 8592920120460 | 22 W  | 1 000 lm      | 3 000-6 500 K | 5 m    | 42 lm/W           | yes      | G             | 1/-/-/10  | <b>2</b> |
| ZPW552R | 8592920120507 | 34 W  | 2 500 lm      | 3 000-6 500 K | 5 m    | 68 lm/W           | yes      | G             | 1/-/-/10  | <b>2</b> |

\* Energy efficiency class on a scale from highest A to lowest G.

# GoSmart ZigBee

EMOS GoSmart LED strips with ZigBee technology will light up your room with all the colours. Control and connect the LED strip to your home WIFI network via a ZigBee gateway and mobile app. LED strips are perfectly suited as decorative backlighting and also modern lighting of the whole room.

**Main benefits:**

- mobile phone app control
- dimming and RGB colour changing option

**Areas of use:** lighting of modern interiors, households and representative areas.

|          |              |
|----------|--------------|
| Lifetime | 20 000 hours |
| CRI      | > 80         |

**NEW** **3 YEARS WARRANTY** **A ↑ G**



Download on the **App Store**  
GET IT ON **Google Play**



EMOS GoSmart



**DIMMABLE** 10% - 100% **CCT** **RGB**

| Type    | EAN           | Power | Luminous Flux | CCT           | Length | Luminous Efficacy | Dimmable | Energy Class* | Packaging | Photo    |
|---------|---------------|-------|---------------|---------------|--------|-------------------|----------|---------------|-----------|----------|
| ZPZ252R | 8592920121030 | 18 W  | 1 400 lm      | 3 000-6 500 K | 2 m    | 72 lm/W           | yes      | G             | 1/-/-/10  | <b>1</b> |
| ZPZ552R | 8592920121054 | 34 W  | 2 500 lm      | 3 000-6 500 K | 5 m    | 68 lm/W           | yes      | G             | 1/-/-/10  | <b>2</b> |

\* Energy efficiency class on a scale from highest A to lowest G.

# EMOS GoSmart

## Smart living even more accessible

Create your own smart home with EMOS GoSmart and other TUYA-compatible smart devices. Connect individual products, set up automation for their activities and control them remotely with a fully localised and intuitive mobile app.



### HOME SECURITY

- Indoor IP cameras
- Outdoor IP cameras
- Video door phones
- Video doorbells
- Door sensors
- Cylinder locks
- PIR sensors



### MEASUREMENT AND CONTROL

- Thermostats
- Weather stations

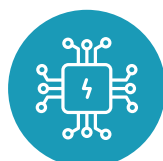

### WIRING AND CONTROL

- Scenic switches
- ZigBee gateways
- Extension cords
- Sockets



### LUMINAIRES AND LIGHT SOURCES

- Bulbs
- Strips
- Luminaires



### HOME AND GARDEN

- Scales
- Feeders



EMOS GoSmart



EMOS GoSmart is here to make your life more pleasant, safer and more comfortable.



# EMOS GoSmart products

## Optimal price/quality ratio

With the affordable prices and excellent quality of EMOS GoSmart products, the smart home system becomes accessible to everyone. You can easily create your smart home without complicated renovation and equipment installation.



### WIDE RANGE OF PRODUCTS

Dozens of EMOS GoSmart products are developed together with the world's leading manufacturers in the industry.



### OPTIMAL PRICE AND QUALITY

EMOS GoSmart products are subject to quality control directly at the manufacturer's and in our laboratory.



### THE ONLY MOBILE APP

The EMOS GoSmart app allows you to control your device via your mobile phone from anywhere.



### TECHNICAL SUPPORT

We provide technical support and help to get EMOS GoSmart products up and running.



### COMPATIBILITY AND EXPANDABILITY

Expand your smart home with EMOS GoSmart products and thousands of other TUYA compatible products.



## Advanced technology

EMOS GoSmart products communicate via Wi-Fi network, Bluetooth or ZigBee communication protocols. You can even use voice control thanks to their compatibility with Amazon Alexa and Google Assistant.



ZigBee



BLE

Works with  
Amazon Alexa  
Google Assistant



Powered by



## Data security and compatibility

### EMOS GoSmart priorities

The basis of the EMOS GoSmart system is the **global TUYA platform**. This platform meets the most demanding security requirements and, using encrypted communication, allows you to connect the devices in your smart home, keeping them compatible and easy to use.

Renowned brands that have chosen **TUYA platform for their smart devices include HAMA, LIDL, LEDVANCE, PHILIPS and many others.**



# EMOS GoSmart app

## Full localisation and ease of use

The EMOS GoSmart app makes it easy to control all your smart home devices via your **Android** or **iOS** mobile phone or tablet. The perfect localisation allows you to communicate with the app in your native language.



Control multiple devices



Never miss a visit



Create and use smart scenarios



Connect from anywhere



Share with your family with one tap



Without complicated settings, you can keep track of any activities in your home with the EMOS GoSmart app and control conveniently all your devices remotely.



### FULL LOCALISATION

The full localisation allows you to communicate with the app in your native language.



### EASY TO USE

You don't have to worry about complicated app controls. Anyone can handle it.



### SMART SCENARIOS

Have your products work together using the smart scenarios.



### DEVICE MANAGEMENT

All your smart home devices can be controlled from anywhere using the app.



### SMART NOTIFICATIONS

The app sends you notifications about any activity in your home.

EMOS GoSmart is here to make your life more pleasant, safer and more comfortable.



# Luminaires

Set up the lighting conditions to suit your current activity and mood the best. You can control the lights throughout your house or apartment, including brightness and colour control, using your smartphone, voice assistant or your remote control.

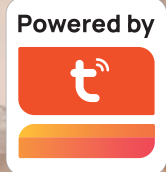

## GoSmart LED luminaires WIFI

Control your modern smart light conveniently from a smartphone app or with your remote control. Adjust the light colour and intensity to create the perfect atmosphere each and every time.

- option to interconnect with other smart home devices
- continuous dimming, light colour adjustment
- timer and night light function

### GoSmart LED luminaire ILVI 30W

- replacement of incandescent bulb: 110 W
- IP rating: IP20
- luminous flux: 1 800 lm
- color temperature: 2 700–6 500 K
- diffuser type: milky
- dimensions: 400 × 70 mm in diameter
- dimming function



1 800 lm

#### Order Code

**ZM5191**

EAN 8592920122570



### GoSmart LED luminaire ILVI 45W

- replacement of incandescent bulb: 160 W
- IP rating: IP20
- luminous flux: 2 700 lm
- color temperature: 2 700–6 500 K
- diffuser type: milky
- dimensions: 500 × 70 mm in diameter
- dimming function



2 700 lm

#### Order Code

**ZM5192**

EAN 8592920122587





**EMOS®**

A brand of **Legrand**

# Christmas lights



Powered by



Enjoy the easy control and adjustment of the lights on your Christmas tree, outdoor decorations or in the interior of your house. Take advantage of the different scene and animation settings, the light color change and customize the lighting to your needs.

## GoSmart LED Christmas chains CLASSIC

The WIFI smart LED Christmas chain EMOS GoSmart can light up Christmas with all the colours. The colour and timer function can be set via the mobile phone app. Thanks to the improved water resistance, you can nicely light up your tree at home as well as outdoors.



- mobile phone app control
- timer and colour changing function
- IP44 protection guarantees water resistance

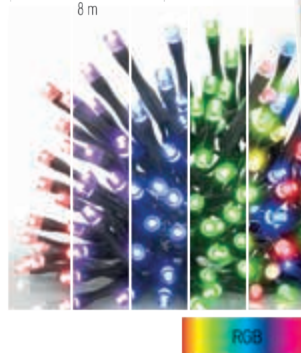
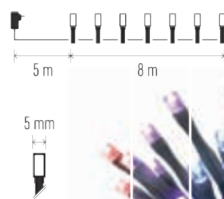

### GoSmart LED Christmas chain CLASSIC 8 m RGB

- dimensions: 8 m
- area of use: both outdoor and indoor
- power supply type: AC adapter

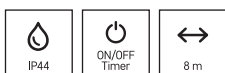

**Order Code**  
**D4ZR01**  
EAN 8592920121702

### GoSmart LED Christmas chain CLASSIC 12 m RGB

- dimensions: 12 m
- area of use: both outdoor and indoor
- power supply type: AC adapter

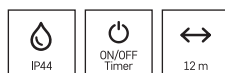

**Order Code**  
**D4ZR02**  
EAN 8592920121726

### GoSmart LED Christmas chain CLASSIC 18 m RGB

- dimensions: 18 m
- area of use: both outdoor and indoor
- power supply type: AC adapter

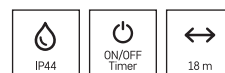

**Order Code**  
**D4ZR03**  
EAN 8592920121740

### GoSmart LED Christmas chain CLASSIC 24 m RGB

- dimensions: 24 m
- area of use: both outdoor and indoor
- power supply type: AC adapter

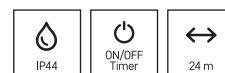

**Order Code**  
**D4ZR04**  
EAN 8592920121764



# LED bulbs

Smart bulbs become your key to home automation. Create scenes and use the lighting settings in your home, from dimming to different colourful light tones. Create a delightful atmosphere and supply your home with not only quality, but also smart lighting.



## GoSmart LED bulbs WIFI

Smart WIFI bulbs can be controlled using a mobile app. The bulbs allow you to pair them into groups and set different properties, such as colour and light intensity, to your liking.

- mobile phone app control
- option to pair multiple bulbs into groups
- dimming and RGB colour changing
- true-to-life RGB colour display



**DIMMABLE**  
10% - 100%

**CCT**

**RGB**

### GoSmart LED bulb A60 9W E27 RGB

- luminous flux: 806 lm
- color temperature: 2 700-6 500 K
- beam angle: 200°
- compatibility: EMOS GoSmart, TUYA, LIDL, Smartlife, open system



**Order Code**  
**ZQW514R**

EAN 8592920120125

### GoSmart LED bulb A60 11W E27 RGB

- luminous flux: 1050 lm
- color temperature: 2 700-6 500 K
- beam angle: 200°
- compatibility: EMOS GoSmart, TUYA, LIDL, Smartlife, open system



**Order Code**  
**ZQW515R**

EAN 8592920120156

### GoSmart LED bulb A60 14W E27 RGB

- luminous flux: 1400 lm
- color temperature: 2 700-6 500 K
- beam angle: 200°
- compatibility: EMOS GoSmart, TUYA, LIDL, Smartlife, open system



**Order Code**  
**ZQW516R**

EAN 8592920120187

### GoSmart LED bulb CANDLE 4.8W E14 RGB

- luminous flux: 470 lm
- color temperature: 2 700-6 500 K
- beam angle: 180°
- compatibility: EMOS GoSmart, TUYA, LIDL, Smartlife, open system



**Order Code**  
**ZQW322R**

EAN 8592920120217

### GoSmart LED bulb MR16 4.8W GU10 RGB

- luminous flux: 400 lm
- color temperature: 2 700-6 500 K
- beam angle: 120°
- compatibility: EMOS GoSmart, TUYA, LIDL, Smartlife, open system



**Order Code**  
**ZQW832R**

EAN 8592920120248

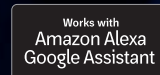
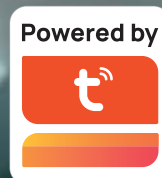

## GoSmart LED bulbs ZigBee

Smart ZigBee bulbs can be controlled using a mobile app. The bulbs allow you to pair them into groups and set different properties, such as colour and light intensity, to your liking.

- mobile phone app control
- option to pair multiple bulbs into groups
- dimming and RGB colour changing
- true-to-life RGB colour display



**ZigBee**

3.0

**DIMMABLE**  
10% – 100%

**CCT**

**RGB**

### GoSmart LED bulb A60 9W E27 RGB

- luminous flux: 806 lm
- color temperature: 2 700–6 500 K
- beam angle: 200°
- compatibility: EMOS GoSmart, TUYA, LIDL, Smartlife, open system



**Order Code**  
**ZQZ514R**  
EAN 8592920121078

### GoSmart LED bulb A60 11W E27 RGB

- luminous flux: 1050 lm
- color temperature: 2 700–6 500 K
- beam angle: 200°
- compatibility: EMOS GoSmart, TUYA, LIDL, Smartlife, open system



**Order Code**  
**ZQZ515R**  
EAN 8592920121108

### GoSmart LED bulb A60 14W E27 RGB

- luminous flux: 1400 lm
- color temperature: 2 700–6 500 K
- beam angle: 200°
- compatibility: EMOS GoSmart, TUYA, LIDL, Smartlife, open system



**Order Code**  
**ZQZ516R**  
EAN 8592920121139

### GoSmart LED bulb CANDLE 4.8W E14 RGB

- luminous flux: 470 lm
- color temperature: 2 700–6 500 K
- beam angle: 180°
- compatibility: EMOS GoSmart, TUYA, LIDL, Smartlife, open system



**Order Code**  
**ZQZ322R**  
EAN 8592920121160

### GoSmart LED bulb MR16 4.8W GU10 RGB

- luminous flux: 400 lm
- color temperature: 2 700–6 500 K
- beam angle: 120°
- compatibility: EMOS GoSmart, TUYA, LIDL, Smartlife, open system



**Order Code**  
**ZQZ832R**  
EAN 8592920121191



# LED strips

Create a unique atmosphere in your interior and gain a full control over your lighting. Monitor energy consumption, create different scenes and animations, and adjust light colours and brightness levels to suit your needs.



## GoSmart LED strips WIFI

You can provide your interior with the right brightness and colour using the EMOS GoSmart smart LED strips with WIFI technology. Thanks to the mobile app, control is always at your fingertips. The LED strips are an excellent solution for both illuminating an entire room and highlighting aesthetic elements.

- control via mobile phone app
- possibility of dimming and changing light colour

### GoSmart LED strip 11 W 2 m RGB

- power: 11 W
- luminous flux: 450 lm
- color temperature: 3 000–6 500 K
- compatibility: EMOS GoSmart, TUYA, LIDL, Smartlife, open systém



**Order Code**  
**ZPW218R**  
EAN 8592920120446

### GoSmart LED strip 18 W 2 m RGB

- power: 18 W
- luminous flux: 1 400 lm
- color temperature: 3 000–6 500 K
- compatibility: EMOS GoSmart, TUYA, LIDL, Smartlife, open systém



**Order Code**  
**ZPW252R**  
EAN 8592920120484

### GoSmart LED strip 22 W 5 m RGB

- power: 22 W
- luminous flux: 1 000 lm
- color temperature: 3 000–6 500 K
- compatibility: EMOS GoSmart, TUYA, LIDL, Smartlife, open systém



**Order Code**  
**ZPW518R**  
EAN 8592920120460

### GoSmart LED strip 34 W 5 m RGB

- power: 34 W
- luminous flux: 2 500 lm
- color temperature: 3 000–6 500 K
- compatibility: EMOS GoSmart, TUYA, LIDL, Smartlife, open systém



**Order Code**  
**ZPW552R**  
EAN 8592920120507



**DIMMABLE**  
10 % – 100 %

CCT

RGB

**3**  
YEARS  
WARRANTY

Powered by



Download on the  
**App Store**

GET IT ON  
**Google Play**

Works with  
Amazon Alexa  
Google Assistant

## GoSmart LED strips ZigBee

EMOS GoSmart smart LED strips with ZigBee technology will light up your room with all colours possible. Control and connect the LED strip to your home WIFI network via a ZigBee gateway and mobile app. The LED strips are perfectly suited as decorative backlighting as well as modern lighting of the entire room.

- control via mobile phone app
- possibility of dimming and changing light colour

### GoSmart LED strip 18 W 2 m RGB

- power: 18 W
- luminous flux: 1 400 lm
- color temperature: 3 000–6 500 K
- compatibility: EMOS GoSmart, TUYA, LIDL, Smartlife, open systém



**Order Code**  
**ZPZ252R**  
EAN 8592920121030

### GoSmart LED strip 34 W 5 m RGB

- power: 34 W
- luminous flux: 2 500 lm
- color temperature: 3 000–6 500 K
- compatibility: EMOS GoSmart, TUYA, LIDL, Smartlife, open systém



**Order Code**  
**ZPZ552R**  
EAN 8592920121054



**ZigBee**

3.0

**DIMMABLE**  
10% – 100%

**CCT**

**RGB**

**3**  
YEARS  
WARRANTY





# ZigBee Gateway

Extend your smart home with more sensors and products. You can conveniently connect them with the ZigBee Gateway and use them to set up automations. Small wireless sensors can work for several years on a single battery thanks to the low power consumption of the ZigBee protocol.



## GoSmart Multifunctional ZigBee gateway

The ZigBee gateway acts as a base unit for smart home and provide connectivity to other sensors and products into one centrally controlled unit. It allows their automations settings.

- Wi-Fi/ZigBee 3.0/BLE/SigMesh communication protocols, easy installation and connection
- with other sensors and products
- miniature size

### GoSmart Multifunctional ZigBee gateway IP-1000Z

- maximum number of connected clients: 50
- compatibility: EMOS GoSmart, TUYA, LIDL, Smartlife, open system
- protocol: Wi-Fi/ZigBee 3.0/BLE/SigMesh
- pairing: automatic, manual
- use: automation
- number of control buttons: 1
- power supply: 5 V DC/1.0 A

**Order Code**

**H5001**

EAN 8592920118627





**EMOS**<sup>®</sup>

A brand of **legrand**

# Extension cords and sockets

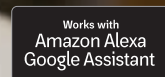
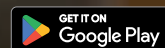
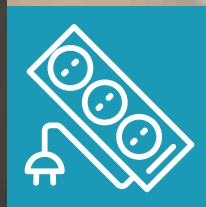
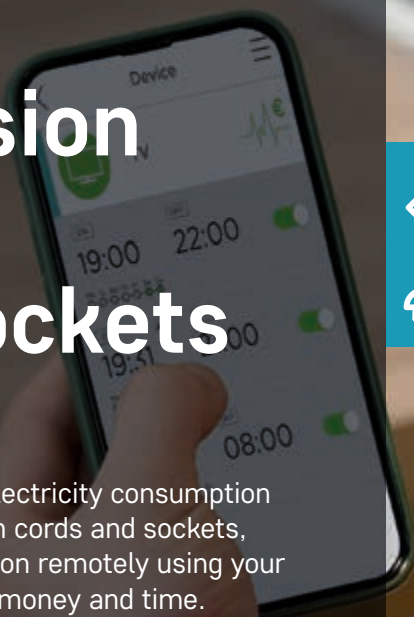

Keep track of your electricity consumption with smart extension cords and sockets, switch them off and on remotely using your mobile device. Save money and time.

## GoSmart Extension cords and sockets

Extension cord with four smart sockets and indoor or outdoor smart power sockets ensures your home running safely and efficiently. These give you control of your connected appliances from anywhere via your mobile phone or tablet.

- switching appliances on and off remotely using your mobile phone
- operation automation of the connected devices
- energy saving and consumption monitoring



### GoSmart Extension cord P1412ST

- maximum load: 3 680 W
- colour: white/black
- conductor: H05VV-F3G;
- type of insulation: PVC
- children protection

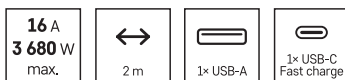

**Order Code**  
**P1412ST**  
EAN 8592920118405

### GoSmart Socket IP-3001F

- maximum load: 3 680 W
- number of switching per day: unlimited
- minimal time setting: 1 minute
- children protection

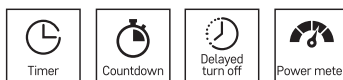

**Order Code**  
**P5551**  
EAN 8592920120095

### GoSmart Socket IP-3005F

- maximum load: 3 680 W
- number of switching per day: unlimited
- minimal time setting: 1 minute
- children protection



**Order Code**  
**P5552**  
EAN 8592920122501



# Scenic switches

Control multiple home electrical devices or lights at once with a single button. With this sophisticated type of switch, you can program different scenes or light effect settings and activate them simply afterwards.

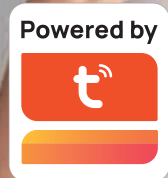

## ZigBee

3.0



### GoSmart ZigBee scene switch IP-2001ZW

- compatibility: EMOS GoSmart, TUYA, LIDL, Smartlife, open system
- protocol: ZigBee 3.0
- pairing: automatic, manual
- use: automation
- number of control buttons: 1
- power supply: CR 2430 3 V

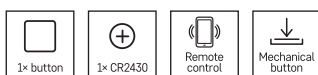

**Order Code**  
**H5011**

EAN 8592920121221



### GoSmart ZigBee scene switch IP-2002ZW

- compatibility: EMOS GoSmart, TUYA, LIDL, Smartlife, open system
- protocol: ZigBee 3.0
- pairing: automatic, manual
- use: automation
- number of control buttons: 2
- power supply: CR 2430 3 V

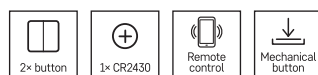

**Order Code**  
**H5012**

EAN 8592920121474



### GoSmart ZigBee scene switch IP-2004ZW

- compatibility: EMOS GoSmart, TUYA, LIDL, Smartlife, open system
- protocol: ZigBee 3.0
- pairing: automatic, manual
- use: automation
- number of control buttons: 4
- power supply: CR 2430 3 V



**Order Code**  
**H5013**

EAN 8592920121498



## How do they work?

Scenic switches link up with other smart home devices using a ZigBee gateway connected to your home WIFI network. You can set up the individual scenes using the EMOS GoSmart mobile app. A special function can be set up for each of the three button positions. Has the sun started to shine and the outside temperature risen? At the touch of a button, you can switch off the room lights, pull down the roller blinds and activate the humidifier all at once.

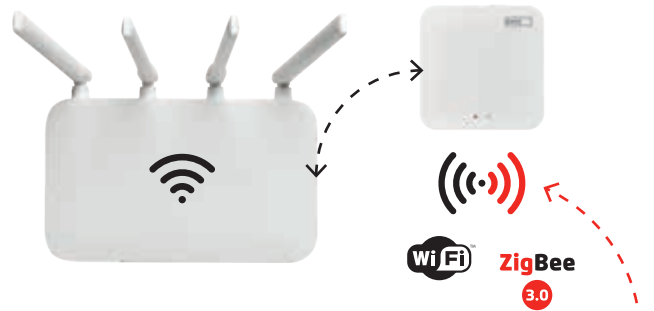

**ZigBee**  
3.0



### GoSmart ZigBee scene switch IP-2001ZB

- compatibility: EMOS GoSmart, TUYA, LIDL, Smartlife, open system
- protocol: ZigBee 3.0
- pairing: automatic, manual
- use: automation
- number of control buttons: 1
- power supply: CR 2430 3 V

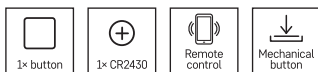

**Order Code**  
**H5014**  
EAN 8592920121511



### GoSmart ZigBee scene switch IP-2002ZB

- compatibility: EMOS GoSmart, TUYA, LIDL, Smartlife, open system
- protocol: ZigBee 3.0
- pairing: automatic, manual
- use: automation
- number of control buttons: 2
- power supply: CR 2430 3 V



**Order Code**  
**H5015**  
EAN 8592920121535



### GoSmart ZigBee scene switch IP-2004ZB

- compatibility: EMOS GoSmart, TUYA, LIDL, Smartlife, open system
- protocol: ZigBee 3.0
- pairing: automatic, manual
- use: automation
- number of control buttons: 4
- power supply: CR 2430 3 V

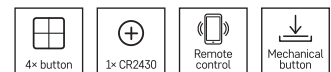

**Order Code**  
**H5016**  
EAN 8592920121559

# INDEX

|        |     |        |     |        |    |        |     |
|--------|-----|--------|-----|--------|----|--------|-----|
| G1110  | 132 | ZC0111 | 124 | ZD3222 | 91 | ZM5172 | 62  |
| G1120  | 133 | ZC0114 | 126 | ZM1114 | 84 | ZM5173 | 62  |
| G1125  | 133 | ZC0116 | 126 | ZM3010 | 83 | ZM5181 | 63  |
| G1130  | 134 | ZC0117 | 126 | ZM3020 | 83 | ZM5182 | 63  |
| G1150  | 134 | ZD1124 | 94  | ZM3130 | 80 | ZM5183 | 63  |
| G1160  | 134 | ZD1125 | 94  | ZM3131 | 81 | ZM5191 | 61  |
| G1180  | 132 | ZD1134 | 94  | ZM3230 | 80 | ZM5192 | 61  |
| G1190  | 132 | ZD1135 | 94  | ZM3231 | 81 | ZM5233 | 68  |
| G1210  | 132 | ZD1144 | 94  | ZM3301 | 76 | ZM5243 | 68  |
| G1240  | 133 | ZD1145 | 94  | ZM3302 | 76 | ZM5253 | 68  |
| Z73113 | 139 | ZD1154 | 94  | ZM3303 | 76 | ZM5333 | 72  |
| Z73114 | 139 | ZD1155 | 94  | ZM3304 | 76 | ZM5343 | 72  |
| Z73123 | 139 | ZD1223 | 98  | ZM3401 | 76 | ZM5353 | 72  |
| Z73124 | 139 | ZD1233 | 98  | ZM3402 | 76 | ZM5432 | 86  |
| Z73133 | 139 | ZD1243 | 98  | ZM3403 | 76 | ZM5442 | 86  |
| Z73134 | 139 | ZD1312 | 106 | ZM3404 | 76 | ZM5452 | 86  |
| Z73215 | 138 | ZD1322 | 106 | ZM3412 | 77 | ZM6123 | 66  |
| Z73216 | 138 | ZD1323 | 102 | ZM3413 | 77 | ZM6133 | 66  |
| Z73225 | 138 | ZD1333 | 102 | ZM4121 | 78 | ZM6143 | 66  |
| Z73226 | 138 | ZD1343 | 102 | ZM4122 | 78 | ZM6153 | 66  |
| Z73235 | 138 | ZD1432 | 108 | ZM4123 | 78 | ZM6233 | 70  |
| Z73236 | 138 | ZD1442 | 108 | ZM4124 | 78 | ZM6243 | 70  |
| ZAL192 | 38  | ZD1452 | 108 | ZM4311 | 82 | ZM6253 | 70  |
| ZAL382 | 38  | ZD2124 | 96  | ZM4312 | 82 | ZM6333 | 74  |
| ZAL382 | 39  | ZD2125 | 96  | ZM4313 | 82 | ZM6343 | 74  |
| ZALAP  | 39  | ZD2134 | 96  | ZM4314 | 82 | ZM6353 | 74  |
| ZALAP  | 39  | ZD2135 | 96  | ZM4321 | 78 | ZM6432 | 87  |
| ZALAR  | 39  | ZD2144 | 96  | ZM4322 | 78 | ZM6442 | 87  |
| ZALAS  | 39  | ZD2145 | 96  | ZM4323 | 78 | ZM6452 | 87  |
| ZALAS  | 39  | ZD2154 | 96  | ZM4324 | 78 | ZN1110 | 128 |
| ZALL   | 38  | ZD2155 | 96  | ZM4325 | 78 | ZN1111 | 129 |
| ZALT   | 38  | ZD2223 | 100 | ZM4328 | 79 | ZN1112 | 129 |
| ZALX   | 38  | ZD2233 | 100 | ZM4329 | 79 | ZN1210 | 128 |
| ZB2114 | 44  | ZD2243 | 100 | ZM5123 | 64 | ZN1211 | 129 |
| ZB2124 | 44  | ZD2323 | 104 | ZM5133 | 64 | ZN1310 | 127 |
| ZB2214 | 47  | ZD2333 | 104 | ZM5143 | 64 | ZN1311 | 129 |
| ZB2224 | 47  | ZD2343 | 104 | ZM5153 | 64 | ZR1412 | 42  |
| ZB2414 | 50  | ZD2432 | 109 | ZM5165 | 56 | ZR1422 | 42  |
| ZC0105 | 125 | ZD2442 | 109 | ZM5166 | 56 | ZR1433 | 42  |
| ZC0106 | 125 | ZD2452 | 109 | ZM5167 | 57 | ZR1532 | 46  |
| ZC0108 | 124 | ZD3121 | 90  | ZM5168 | 59 | ZR1612 | 45  |
| ZC0109 | 124 | ZD3122 | 90  | ZM5169 | 59 | ZR1622 | 45  |
| ZC0110 | 124 | ZD3221 | 91  | ZM5171 | 62 | ZR1642 | 45  |

|               |     |               |    |               |     |               |     |
|---------------|-----|---------------|----|---------------|-----|---------------|-----|
| ZR1722 .....  | 40  | ZS2223.....   | 24 | ZS2911.....   | 23  | ZU215.12..... | 112 |
| ZR1723 .....  | 40  | ZS2231.2..... | 31 | ZS2920.....   | 21  | ZU220.6.....  | 113 |
| ZR2212 .....  | 43  | ZS2232.....   | 25 | ZS2921.....   | 23  | ZU220.9.....  | 113 |
| ZR3412 .....  | 43  | ZS2233.....   | 24 | ZS2930.....   | 21  | ZU220.12..... | 113 |
| ZR3422 .....  | 43  | ZS2242.....   | 25 | ZS2931.....   | 23  | ZU9001.....   | 116 |
| ZR5410 .....  | 48  | ZS2243.....   | 24 | ZS2940.....   | 21  | ZU9002.....   | 116 |
| ZR5412 .....  | 48  | ZS2312.....   | 27 | ZS2941.....   | 23  | ZU9003.....   | 116 |
| ZR5421 .....  | 48  | ZS2313.....   | 26 | ZS3322.....   | 32  | ZU9004.....   | 116 |
| ZR5422 .....  | 48  | ZS2322.....   | 27 | ZS3332.....   | 32  | ZU9005.....   | 116 |
| ZR7612M.....  | 47  | ZS2323.....   | 26 | ZS3342.....   | 32  | ZU9902.....   | 116 |
| ZR8412 .....  | 49  | ZS2332.....   | 27 | ZS3360F.....  | 30  | ZV1112.....   | 92  |
| ZR9001 .....  | 51  | ZS2333.....   | 26 | ZS3360S.....  | 30  | ZV1122.....   | 92  |
| ZR9002 .....  | 51  | ZS2342.....   | 27 | ZS9010.....   | 28  | ZV1132.....   | 92  |
| ZR9010 .....  | 51  | ZS2343.....   | 26 | ZS9020.....   | 28  | ZV1142.....   | 92  |
| ZR9011 .....  | 51  | ZS2412.....   | 10 | ZS9030.....   | 28  | ZV1152.....   | 92  |
| ZR9020 .....  | 51  | ZS2422.....   | 10 | ZS9510.....   | 28  | ZV2112.....   | 93  |
| ZR9021 .....  | 51  | ZS2432.....   | 10 | ZT1040.....   | 118 | ZV2122.....   | 93  |
| ZR9034 .....  | 51  | ZS2452.....   | 11 | ZT1520.....   | 119 | ZV2132.....   | 93  |
| ZR9035 .....  | 51  | ZS2462.....   | 11 | ZT1520D.....  | 119 | ZV2142.....   | 93  |
| ZR9036 .....  | 51  | ZS2472.....   | 11 | ZT1520E.....  | 119 | ZV2152.....   | 93  |
| ZR9041 .....  | 48  | ZS2510.....   | 20 | ZT1521.....   | 118 | ZZ409BD.....  | 134 |
| ZR9041 .....  | 51  | ZS2511.....   | 22 | ZT1530.....   | 119 | ZZ1435T.....  | 134 |
| ZR9310.....   | 127 | ZS2520.....   | 20 | ZT1531.....   | 118 | ZZ2055T.....  | 134 |
| ZS1050A.....  | 13  | ZS2521.....   | 22 | ZT1620.....   | 119 | ZZ3070T.....  | 134 |
| ZS1050B.....  | 14  | ZS2530.....   | 20 | ZT1620D.....  | 119 |               |     |
| ZS1050N.....  | 15  | ZS2531.....   | 22 | ZT1620E.....  | 119 |               |     |
| ZS1100A.....  | 13  | ZS2540.....   | 20 | ZT1621.....   | 118 |               |     |
| ZS1100B.....  | 14  | ZS2541.....   | 22 | ZT1630.....   | 119 |               |     |
| ZS1100N.....  | 15  | ZS2612.....   | 16 | ZT1631.....   | 118 |               |     |
| ZS1200A.....  | 13  | ZS2622.....   | 16 | ZT3020.....   | 121 |               |     |
| ZS1200B.....  | 14  | ZS2632.....   | 16 | ZT3120.....   | 121 |               |     |
| ZS1200N.....  | 15  | ZS2642.....   | 16 | ZT3220.....   | 121 |               |     |
| ZS1300A.....  | 13  | ZS2652.....   | 17 | ZT4320.....   | 120 |               |     |
| ZS1300B.....  | 14  | ZS2662.....   | 17 | ZT4420.....   | 120 |               |     |
| ZS1300N.....  | 15  | ZS2672.....   | 17 | ZT4520.....   | 120 |               |     |
| ZS2110.....   | 130 | ZS2712.....   | 18 | ZU083.....    | 114 |               |     |
| ZS2120.....   | 130 | ZS2722.....   | 18 | ZU133.....    | 114 |               |     |
| ZS2130.....   | 130 | ZS2732.....   | 18 | ZU166.....    | 115 |               |     |
| ZS2140.....   | 130 | ZS2742.....   | 18 | ZU210.6.....  | 112 |               |     |
| ZS2212.....   | 25  | ZS2812.....   | 33 | ZU210.9.....  | 112 |               |     |
| ZS2213.....   | 24  | ZS2822.....   | 33 | ZU210.12..... | 112 |               |     |
| ZS2221.2..... | 31  | ZS2832.....   | 33 | ZU215.6.....  | 112 |               |     |
| ZS2222.....   | 25  | ZS2910.....   | 21 | ZU215.9.....  | 112 |               |     |







SPEED  
AND EASY OF  
COMMUNICATION

## Making Life Easy

EMOS spol. s r.o.  
Lipnicka 2844  
750 02 Prerov  
Czech Republic

e-mail: [orders@emos.cz](mailto:orders@emos.cz)  
phone: +420 581 261 207  
fax: +420 581 261 112

[www.emos.eu](http://www.emos.eu)

Y10967



8 592920 122556